

## CE EMC Test Report

### (EN 50155 & EN 50121-3-2)

**Report No.:** CE160624D11

**Test Model:** SPC-3530-600U

**Series Model:** SPC-XXXX-XXXX series  
(“X” can be 0-9, A-Z or blank for marketing purpose)

**Received Date:** Jun. 30, 2016

**Test Date:** Jul. 11 ~ 20, 2016

**Issued Date:** Aug. 8, 2016

**Applicant:** Vecow Co., Ltd.

**Address:** 12F., No. 111, Zhongcheng Rd., Tucheng Dist., New Taipei City 23674  
Taiwan (R.O.C.)

**Issued By:** Bureau Veritas Consumer Products Services (H.K.) Ltd., Taoyuan Branch

**Lab Address:** No. 47-2, 14th Ling, Chia Pau Vil., Lin Kou Dist., New Taipei City, Taiwan  
(R.O.C.)

This report is for your exclusive use. Any copying or replication of this report to or for any other person or entity, or use of our name or trademark, is permitted only with our prior written permission. This report sets forth our findings solely with respect to the test samples identified herein. The results set forth in this report are not indicative or representative of the quality or characteristics of the lot from which a test sample was taken or any similar or identical product unless specifically and expressly noted. Our report includes all of the tests requested by you and the results thereof based upon the information that you provided to us. You have 60 days from date of issuance of this report to notify us of any material error or omission caused by our negligence, provided, however, that such notice shall be in writing and shall specifically address the issue you wish to raise. A failure to raise such issue within the prescribed time shall constitute your unqualified acceptance of the completeness of this report, the tests conducted and the correctness of the report contents. Unless specific mention, the uncertainty of measurement has been explicitly taken into account to declare the compliance or non-compliance to the specification. The report must not be used by the client to claim product certification, approval, or endorsement by any government agencies.

## Table of Contents

<b>Release Control Record</b> .....	<b>4</b>
<b>1 Certificate of Conformity</b> .....	<b>5</b>
<b>2 Summary of Test Results</b> .....	<b>6</b>
2.1 Performance Criteria .....	8
2.2 Measurement Uncertainty.....	8
2.3 Modification Record.....	8
<b>3 General Information</b> .....	<b>9</b>
3.1 Features of EUT .....	9
3.2 General Description of EUT .....	9
3.3 Operating Modes of EUT and Determination of Worst Case Operating Mode .....	10
3.4 Test Program Used and Operation Descriptions.....	11
3.5 Primary Clock Frequencies of Internal Source .....	11
<b>4 Configuration and Connections with EUT</b> .....	<b>12</b>
4.1 Connection Diagram of EUT and Peripheral Devices .....	12
4.2 Configuration of Peripheral Devices and Cable Connections.....	14
<b>5 Conducted Disturbance at Auxiliary a.c. or d.c. Power Ports</b> .....	<b>16</b>
5.1 Limits .....	16
5.2 Test Instruments .....	16
5.3 Test Arrangement .....	17
5.4 Test Results.....	18
<b>6 Radiated Disturbance up to 1 GHz</b> .....	<b>20</b>
6.1 Limits .....	20
6.2 Test Instruments .....	20
6.3 Test Arrangement .....	21
6.4 Test Results.....	22
<b>7 Electrostatic Discharge Immunity Test (ESD)</b> .....	<b>24</b>
7.1 Test Specification.....	24
7.2 Test Instruments .....	24
7.3 Test Arrangement .....	25
7.4 Test Results.....	26
<b>8 Radio-frequency Electromagnetic Field Immunity Test (RS)</b> .....	<b>30</b>
8.1 Test Specification.....	30
8.2 Test Instruments .....	30
8.3 Test Arrangement .....	31
8.4 Test Results.....	32
<b>9 Electrical Fast Transient/Burst Immunity Test (EFT)</b> .....	<b>33</b>
9.1 Test Specification.....	33
9.2 Test Instruments .....	33
9.3 Test Arrangement .....	34
9.4 Test Results.....	35
<b>10 Surge Immunity Test</b> .....	<b>36</b>
10.1 Test Specification.....	36
10.2 Test Instruments .....	36
10.3 Test Arrangement .....	37
10.4 Test Results.....	38

<b>11 Immunity to Conducted Disturbances Induced by RF Fields (CS)</b> .....	<b>39</b>
11.1 Test Specification.....	39
11.2 Test Instruments.....	40
11.3 Test Arrangement.....	41
11.4 Test Results.....	42
<b>12 Pictures of Test Arrangements</b> .....	<b>43</b>
12.1 Conducted Disturbance at Auxiliary a.c. or d.c. power ports.....	43
12.2 Radiated Disturbance up to 1 GHz.....	44
12.3 Electrostatic Discharge Immunity Test (ESD).....	45
12.4 Radio-frequency Electromagnetic Field Immunity Test (RS).....	46
12.5 Fast Transients (EFT).....	47
12.6 Surge.....	48
12.7 Radio-frequency common mode (CS).....	49
<b>Appendix – Information on the Testing Laboratories</b> .....	<b>50</b>

### Release Control Record

Issue No.	Description	Date Issued
CE160624D11	Original release.	Aug. 8, 2016

## 1 Certificate of Conformity

**Product:** Ultra-compact Fanless Embedded Box PC

**Brand:** Vecow

**Test Model:** SPC-3530-600U

**Series Model:** SPC-XXXX-XXXX series ( "X" can be 0-9, A-Z or blank for marketing purpose)

**Sample Status:** Engineering sample

**Applicant:** Vecow Co., Ltd.

**Test Date:** Jul. 11 ~ 20, 2016

**Standards:** **EN 50155:2007 +AC:2010 +AC:2012, Clause 12.2.7 & 12.2.8**  
**EN 50121-1:2006 +AC:2008**  
**EN 50121-3-2:2006 +AC:2008**  
EN 55011:2009 +A1:2010  
EN 61000-4-2:2009  
EN 61000-4-3:2006 +A1:2008 +A2:2010  
EN 61000-4-4:2012  
EN 61000-4-5:2014  
EN 61000-4-6:2014

The above equipment has been tested by **Bureau Veritas Consumer Products Services (H.K.) Ltd., Taoyuan Branch**, and found compliance with the requirement of the above standards. The test record, data evaluation & Equipment Under Test (EUT) configurations represented herein are true and accurate accounts of the measurements of the sample's EMC characteristics under the conditions specified in this report.

Prepared by :  , Date: Aug. 8, 2016  
Celia Chen / Supervisor

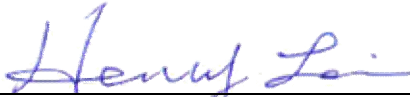
Approved by :  , Date: Aug. 8, 2016  
Henry Lai / Director

## 2 Summary of Test Results

EN 50121-3-2:2006 + AC:2008, Emission EN 50155:2007 +AC:2010 +AC:2012, Clause 12.2.8.2					
Table Clause	Basic Standard	Port	Test Item / specifications	Result/Remarks	Verdict
3.1	EN 55011:2009 +A1:2010	Auxiliary a.c. or d.c. power ports - Auxiliary supply sinusoidal a.c. or d.c.	Conducted disturbance 9 kHz-150 kHz: no limits 150 kHz- 500 kHz: 99 dB $\mu$ V quasi-peak 500 kHz- 30 MHz: 93 dB $\mu$ V quasi-peak	Minimum passing margin is -45.41 dB at 0.17734 MHz	Pass
6.1	EN 55011:2009 +A1:2010	Enclosure	Radiated disturbance 30 MHz- 230 MHz: 40 dB $\mu$ V/m quasi-peak 230 MHz -1 GHz: 47 dB $\mu$ V/m quasi-peak	Minimum passing margin is -2.01 dB at 742.50 MHz	Pass

EN 50121-3-2:2006 + AC:2008, Immunity requirements, EN 50155:2007 +AC:2010 +AC:2012, Clause 12.2.7 & 12.2.8.1					
Table Clause	Basic standard	Port	Test Item / specifications	Result/Remarks	Verdict
7.1	EN 61000-4-6:2014	Auxiliary a.c. power input ports (rated voltage $\leq$ 400 Vrms)	Radio-frequency common mode (CS) 80% AM (1kHz) 0.15-80 MHz, 10V Performance Criterion A	Performance Criterion A	Pass
7.2	EN 61000-4-4:2012	Auxiliary a.c. power input ports (rated voltage $\leq$ 400 Vrms)	Fast Transients (EFT) 5/50 ( $T_r/T_h$ ) ns, 5kHz $\pm$ 2kV Performance Criterion A	Performance Criterion B	Pass
7.3	EN 61000-4-5:2014	Auxiliary a.c. power input ports (rated voltage $\leq$ 400 Vrms)	Surges 1.2/50 (8/20) ( $T_r/T_h$ ) $\mu$ s Line to ground: $\pm$ 2kV 42 $\Omega$ , 0.5 $\mu$ F Line to line: $\pm$ 1kV 42 $\Omega$ , 0.5 $\mu$ F Performance Criterion B	Performance Criterion A	Pass
8.1	EN 61000-4-6:2014	Signal & communication, process measurement & control ports	Radio-frequency common mode (CS) 80% AM (1kHz) 0.15-80 MHz, 10V Performance Criterion A	Performance Criterion A	Pass
8.2	EN 61000-4-4:2012	Signal & communication, process measurement & control ports	Fast Transients (EFT) 5/50 ( $T_r/T_h$ ) ns, 5kHz $\pm$ 2kV, Capacitive clamp Performance Criterion A	Performance Criterion B	Pass

EN 50121-3-2:2006 + AC:2008, Immunity requirements,  
EN 50155:2007 +AC:2010 +AC:2012, Clause 12.2.7 & 12.2.8.1

Table Clause	Basic standard	Port	Test Item / specifications	Result/Remarks	Verdict
9.1	EN 61000-4-3:2006 +A1:2008 +A2:2010	Enclosure ports	Radio-frequency electromagnetic field amplitude modulated (RS) <sup>1</sup> , 80% AM (1kHz) 80-1000 MHz, 20V/m Performance Criterion A	Performance Criterion A	Pass
9.2	EN 61000-4-3:2006 +A1:2008 +A2:2010	Enclosure ports	Radio-frequency electromagnetic field from digital mobile telephones (RS) <sup>2</sup> , 80% AM (1kHz) 800-1000 MHz, 20V/m 1400-2100 MHz, 10V/m 2100-2500 MHz, 5V/m Performance Criterion A	Performance Criterion A	Pass
9.3	EN 61000-4-2:2009	Enclosure ports	Electrostatic Discharges (ESD) ±6kV Contact discharge ±8kV Air discharge Performance Criterion B	Performance Criterion B	Pass

Note 1: This limit applies to equipment mounted in the passenger compartments, drivers cab or external to the rolling stock (roof, underframe). For equipment mounted in all other areas a severity level of 10 V/m may be used.

Note 2: For large apparatus (e.g. traction drives, auxiliary converters) it is often not practical to perform the immunity test to radiated electromagnetic fields on the complete unit. In such cases the manufacturer should test susceptible sub-systems (e.g. control electronics). The test report should justify the selection or not of sub-systems and any assumptions made (e.g. reduction of field due to case shielding).

Note:

1. There is no deviation to the applied test methods and requirements covered by the scope of this report.
2. The above EN basic standards are applied with latest version if customer has no special requirement.

## 2.1 Performance Criteria

### General Performance Criteria

The general performance criteria apply for those ports for which no specific performance criteria are defined (e.g. auxiliary ports) in the report.

**Performance criterion A:** The apparatus shall continue to operate as intended during and after the test. No degradation of performance or loss of function is allowed below a performance level specified by the manufacturer, when the apparatus is used as intended. The performance level may be replaced by a permissible loss of performance. If the minimum performance level or the permissible performance loss is not specified by the manufacturer, either of these may be derived from the product description and documentation, and from what the user may reasonably expect from the apparatus if used as intended..

**Performance criterion B:** The apparatus shall continue to operate as intended after the test. No degradation of performance or loss of function is allowed below a performance level specified by the manufacturer, when the apparatus is used as intended. The performance level may be replaced by a permissible loss of performance. During the test, degradation of performance is however allowed. No change of actual operating state or stored data is allowed. If the minimum performance level or the permissible performance loss is not specified by the manufacturer, either of these may be derived from the product description and documentation, and from what the user may reasonably expect from the apparatus if used as intended.

**Performance criterion C:** Temporary loss of function is allowed, provided the function is selfrecoverable or can be restored by the operation of the controls.

### 2.2 Measurement Uncertainty

Where relevant, the following measurement uncertainty levels have been estimated for tests performed on the EUT as specified in CISPR 16-4-2:

The listed uncertainties are the worst case uncertainty for the entire range of measurement. Please note that the uncertainty values are provided for informational purposes only and are not used in determining the PASS/FAIL results.

Measurement	Expanded Uncertainty (k=2) ( $\pm$ )	Maximum allowable uncertainty ( $\pm$ )
Conducted disturbance at mains port using AMN, 150kHz ~ 30MHz	2.78 dB	3.4 dB ( $U_{\text{cispr}}$ )
Radiated disturbance, 30MHz ~ 1GHz	3.73 dB	6.3 dB ( $U_{\text{cispr}}$ )

The other instruments specified are routine verified to remain within the calibrated levels, no measurement uncertainty is required to be calculated.

### 2.3 Modification Record

There were no modifications required for compliance.



### 3 General Information

#### 3.1 Features of EUT

The tests reported herein were performed according to the method specified by Vecow Co., Ltd., for detailed feature description, please refer to the manufacturer's specifications or user's manual.

#### 3.2 General Description of EUT

Product	Ultra-compact Fanless Embedded Box PC
Brand	Vecow
Test Model	SPC-3530-600U
Series Model	SPC-XXXX-XXXX series ( "X" can be 0-9, A-Z or blank for marketing purpose)
Model Difference	For marketing purpose
Sample Status	Engineering sample
Operating Software	Windows 10, Windows 8.1, Windows 7, Linux
Power Supply Rating	12V to 36V, DC-in
Accessory Device	Adapter
Data Cable Supplied	N/A

Note:

1. The EUT is a Ultra-compact Fanless Embedded Box PC with following interfaces:

- 2 COM\*9 (RS-232/ 422/ 485)
- 2 USB 3.0\*4
- 2 Isolated DIO\*16 (DI\*8, DO\*8)
- 2 DVI (resolution up to 1920 x 1080 @ 60Hz)
- 2 Display (resolution up to 3840 x 2160 @ 30Hz)
- 2 Line out
- 2 Mic. in
- 2 LAN (10/100/1000Mbps)\*4
- 2 DC input

2. The EUT was configured with the following key components:

Component	Brand	Model No. or P/N	Spec.
CPU	Intel	Core™ i7-6600U	3.4GHz
Memory	Transcend	C71906-0010	8GB 2Rx8 DDR4 2133 SO
HDD	HITACHI	HTS542580K9SA00	80GB
4-port RS-232/ 422/ 485 Serial Card	Vecow	SMX-100	RS-232/ 422/ 485
Mini PCIe 2-port Gigabit LAN Card	Vecow	LMX-200	10/100/1000Mbps
Motherboard	Vecow	EMBC-1XXXX-XXXX series	--

3. The EUT uses following adapter.

Brand	MW
Model	GS160A24
Input Power	100-240Vac, 50/60Hz, 2.0A
Output Power	24V, 6.67A, 160W max.
Power Line	Non-shielded DC (1.2m) with one ferrite core

### 3.3 Operating Modes of EUT and Determination of Worst Case Operating Mode

The EUT is designed with AC power of rating 100-240Vac, 50/60Hz.

For radiated emission evaluation, 230Vac/50Hz & 110Vac/60Hz (for EN 55032), 230Vac/50Hz (for EN 55011), 120Vac/60Hz (for FCC Part 15) had been covered during the pre-test. The worst data was found at **110Vac/60Hz** and recorded in the applied test report. Then the other test items were tested at 230Vac/50Hz.

Test modes are presented in the report as below.

Mode	Test Condition
Conducted emission test	
1	Full system, Display (3840 x 2160, 30Hz) + DVI (1920 x 1080, 60Hz), 230Vac/ 50Hz
Radiated emission test	
1	Full system, Display (3840 x 2160, 30Hz) + DVI (1920 x 1080, 60Hz), 110Vac/ 60Hz
Immunity tests	
1	Full system, Display (3840 x 2160, 30Hz) + DVI (1920 x 1080, 60Hz), 230Vac/ 50Hz

### 3.4 Test Program Used and Operation Descriptions

#### Emission tests:

- a. Turned on the power of all equipment.
- b. EUT ran a test program to enable all functions.
- c. EUT read and wrote messages from/to HDD/SSD and ext. HDDs.
- d. EUT sent and received messages to/from Notebook PCs (kept in a remote area) via four UTP LAN cables.
- e. EUT sent "H" messages to ext. LCD Monitors. Then they displayed "H" patterns on their screens simultaneously.
- f. EUT sent 1kHz audio signal to earphone.
- g. EUT sent messages to modems.
- h. EUT sent messages to printer. Then it printed them out simultaneously.
- i. Steps c-h were repeated.

#### Immunity tests:

- a. Turned on the power of all equipment.
- b. EUT ran a test program to enable all functions.
- c. EUT read and wrote messages from/to HDD/SSD and external USB flash.
- d. EUT sent and received messages to/from Notebook PC (kept in a remote area) via Hub with four UTP LAN cables.
- e. EUT sent "H" messages to ext. LCD Monitors. Then they displayed "H" patterns on their screens simultaneously.
- f. EUT sent audio signal to speaker.
- g. EUT sent messages to modems.
- h. Steps c-g were repeated.

### 3.5 Primary Clock Frequencies of Internal Source

The highest frequency generated or used within the EUT or on which the EUT operates or tunes is 3400MHz, provided by Vecow Co., Ltd., for detailed internal source, please refer to the manufacturer's specifications.

## 4 Configuration and Connections with EUT

### 4.1 Connection Diagram of EUT and Peripheral Devices

Emission tests:

#### TEST CONFIGURATION

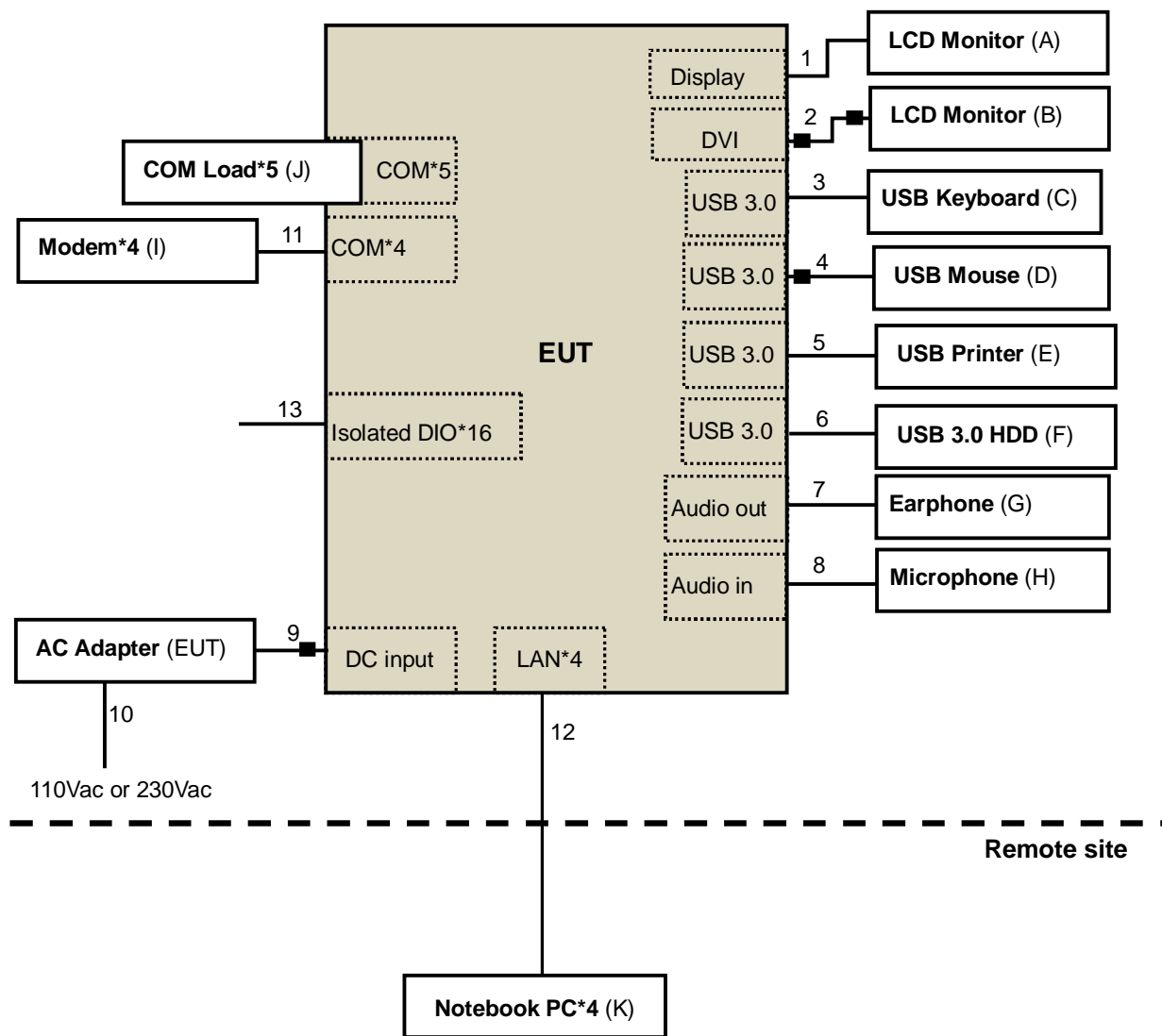

Immunity tests:

### TEST CONFIGURATION

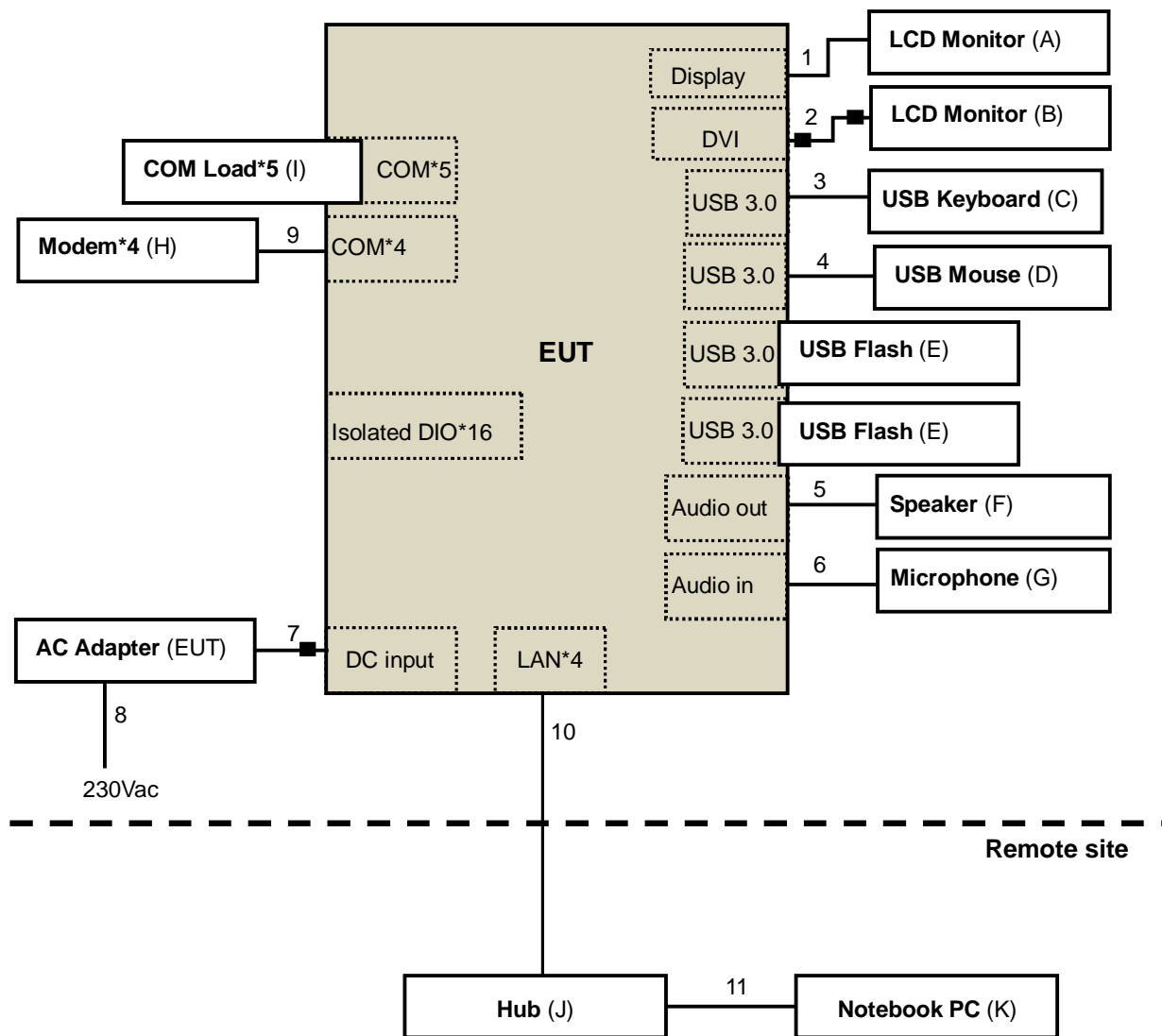

## 4.2 Configuration of Peripheral Devices and Cable Connections

### Emission tests:

ID	Product	Brand	Model No.	Serial No.	FCC ID	Remarks
A.	LCD Monitor	ASUS	PB287QR	N/A	FCC DOC Approved	Provided by Lab
B.	LCD Monitor	View Sonic	VG2860mhl	N/A	FCC DOC Approved	Provided by Lab
C.	USB KEYBOARD	BTC	5200U	G09302046630	E5XKB5122U	Provided by Lab
D.	USB Mouse	Microsoft	1113	9170515772199	FCC DoC Approved	Provided by Lab
E.	USB PRINTER	LEXMARK	Z33	N/A	FCC DoC Approved	Provided by Lab
F.	USB 3.0 Hard Disk	WD	WDBUZG0010BB K-PESN	WX61A45JRTS8	FCC DoC Approved	Provided by Lab
G.	EARPHONE	PHILIPS	SBC HL145	N/A	N/A	Provided by Lab
H.	MICROPHONE	Labtec	mic-333	N/A	N/A	Provided by Lab
I.	MODEM	ACEEX	1414	980020569	IFAXDM1414	Provided by Lab
	MODEM	ACEEX	1414	980020532	IFAXDM1414	Provided by Lab
	MODEM	ACEEX	1414	980020534	IFAXDM1414	Provided by Lab
	MODEM	ACEEX	1414	980020538	IFAXDM1414	Provided by Lab
J.	COM Load*5	N/A	N/A	N/A	N/A	Supplied by client
K.	Notebook PC	DELL	P41G	HT4W952	FCC DoC Approved	Provided by Lab
	Notebook PC	SONY	SVS151A12P	275548477001024	FCC DoC Approved	Provided by Lab
	Notebook PC	DELL	P41G	6BZY242	FCC DoC Approved	Provided by Lab
	Notebook PC	DELL	PP27L	8SNZ12S	FCC DoC Approved	Provided by Lab

### Note:

1. All power cords of the above support units are non-shielded (1.8m).
2. Items K acted as communication partners to transfer data.

ID	Descriptions	Qty.	Length (m)	Shielding (Yes/No)	Cores (Qty.)	Remarks
1.	Display cable	1	1.5	Y	0	Provided by Lab
2.	DVI cable	1	1.8	Y	2	Provided by Lab
3.	USB cable	1	1.5	Y	0	Provided by Lab
4.	USB cable	1	1.8	Y	1	Provided by Lab
5.	USB cable	1	1.8	Y	0	Provided by Lab
6.	USB cable	1	0.5	Y	0	Provided by Lab
7.	Audio cable	1	1.0	N	0	Provided by Lab
8.	Audio cable	1	2.2	N	0	Provided by Lab
9.	DC cable	1	1.2	N	1	Supplied by client
10.	AC power cord	1	1.8	N	0	Provided by Lab
11.	RS232 cable	4	1.0	Y	0	Provided by Lab
12.	LAN cable	4	10.0	N	0	Provided by Lab
13.	Data cable	3	1.0	N	0	Supplied by client

Note: The core(s) is(are) originally attached to the cable(s).

**Immunity tests:**

ID	Product	Brand	Model No.	Serial No.	FCC ID	Remarks
A.	LCD Monitor	DELL	2408WFP	CN0NN792742618481 YVS	FCC DoC Approved	Provided by Lab
B.	LCD Monitor	DELL	U2410	CN082WXD728720CC 0YAL	FCC DoC Approved	Provided by Lab
C.	USB KEYBOARD	HP	SK-2885	N/A	FCC DoC Approved	Provided by Lab
D.	USB Mouse	Lenovo	M-UAE119	N/A	FCC DoC Approved	Provided by Lab
E.	USB Flash*2	PNY	16GB	N/A	N/A	Provided by Lab
F.	SPEAKER	SANYO	SYSP-802	SP07500040300791	N/A	Provided by Lab
G.	MICROPHONE	Ergotech	N/A	N/A	N/A	Provided by Lab
H.	MODEM	ACEEX	1414	980020532	IFAXDM1414	Provided by Lab
	MODEM	ACEEX	1414	980020530	IFAXDM1414	Provided by Lab
	MODEM	ACEEX	1414	0206026742	IFAXDM1414	Provided by Lab
	MODEM	ACEEX	1414	0206026745	IFAXDM1414	Provided by Lab
I.	COM Load*5	N/A	N/A	N/A	N/A	Supplied by client
J.	Hub	FXC	XGS-5610TS	N/A	N/A	Provided by Lab
K.	Notebook PC	Lenovo	L440	R90FCKH8	FCC DoC Approved	Provided by Lab

**Note:**

1. All power cords of the above support units are non-shielded (1.8m).
2. Items J-K acted as communication partners to transfer data.

ID	Descriptions	Qty.	Length (m)	Shielding (Yes/No)	Cores (Qty.)	Remarks
1.	Display cable	1	1.8	Y	0	Provided by Lab
2.	DVI cable	1	1.8	Y	2	Provided by Lab
3.	USB cable	1	1.8	Y	0	Provided by Lab
4.	USB cable	1	1.8	Y	0	Provided by Lab
5.	Audio cable	1	1.0	N	0	Provided by Lab
6.	Audio cable	1	1.5	N	0	Provided by Lab
7.	DC cable	1	1.2	N	1	Supplied by client
8.	AC power cord	1	1.8	N	0	Provided by Lab
9.	RS232 cable	4	1.0	Y	0	Provided by Lab
10.	LAN cable (For immunity test except for CS test)	4	10.0	N	0	Provided by Lab
	LAN cable (For CS test only)	4	10.0	Y	0	Provided by Lab
11.	LAN cable	1	3.0	N	0	Provided by Lab

Note: The core(s) is(are) originally attached to the cable(s).

## 5 Conducted Disturbance at Auxiliary a.c. or d.c. Power Ports

### 5.1 Limits

Frequency (MHz)	Quasi-peak, (dBuV)
0.009 - 0.15	no limits
0.15 - 0.5	99
0.5 - 30	93

Notes: 1. The lower limit shall apply at the transition frequencies.  
 2. The limit decreases linearly with the logarithm of the frequency in the range of 0.15 to 0.50 MHz.

### 5.2 Test Instruments

Description & Manufacturer	Model No.	Serial No.	Cal. Date	Cal. Due
ROHDE & SCHWARZ TEST RECEIVER	ESCS 30	100276	Apr. 12, 2016	Apr. 11, 2017
ROHDE & SCHWARZ Artificial Mains Network (for EUT)	ENV216	101197	May 04, 2016	May 03, 2017
LISN With Adapter (for EUT)	AD10	C10Ada-002	May 04, 2016	May 03, 2017
ROHDE & SCHWARZ Artificial Mains Network (for peripherals)	ESH3-Z5	100218	Nov. 25, 2015	Nov. 24, 2016
SCHWARZBECK Artificial Mains Network (For EUT)	NNLK8129	8129229	May 04, 2016	May 03, 2017
Software	Cond_V7.3.7	NA	NA	NA
RF cable (JYEBAO) With 10dB PAD	5D-FB	Cable-C10.01	Feb. 15, 2016	Feb. 14, 2017
SUHNER Terminator (For ROHDE & SCHWARZ LISN)	65BNC-5001	E1-011484	May 12, 2016	May 11, 2017
ROHDE & SCHWARZ Artificial Mains Network (For TV EUT)	ESH3-Z5	100220	Nov. 13, 2015	Nov. 12, 2016
LISN With Adapter (for TV EUT)	100220	N/A	Nov. 13, 2015	Nov. 12, 2016

Notes: 1. The calibration interval of the above test instruments is 12 months and the calibrations are traceable to NML/ROC and NIST/USA.  
 2. The test was performed in Shielded Room No. 10.  
 3. The VCCI Site Registration No. C-1852.  
 4. Tested Date: Jul. 11, 2016.



### 5.3 Test Arrangement

- The EUT was placed 0.4 meters from the conducting wall of the shielded room with EUT being connected to the power mains through a line impedance stabilization network (LISN). Other support units were connected to the power mains through another LISN. The two LISNs provide 50 Ohm/ 50uH of coupling impedance for the measuring instrument.
- Both lines of the power mains connected to the EUT were checked for maximum conducted interference.
- The test results of conducted emissions at mains ports are recorded of six worst margins for quasi-peak (mandatory) [and average (if necessary)] values against the limits at frequencies of interest unless the margin is 20 dB or greater.

Note: The resolution bandwidth and video bandwidth of test receiver is 9kHz for quasi-peak detection (QP) at frequency 0.15MHz-30MHz.

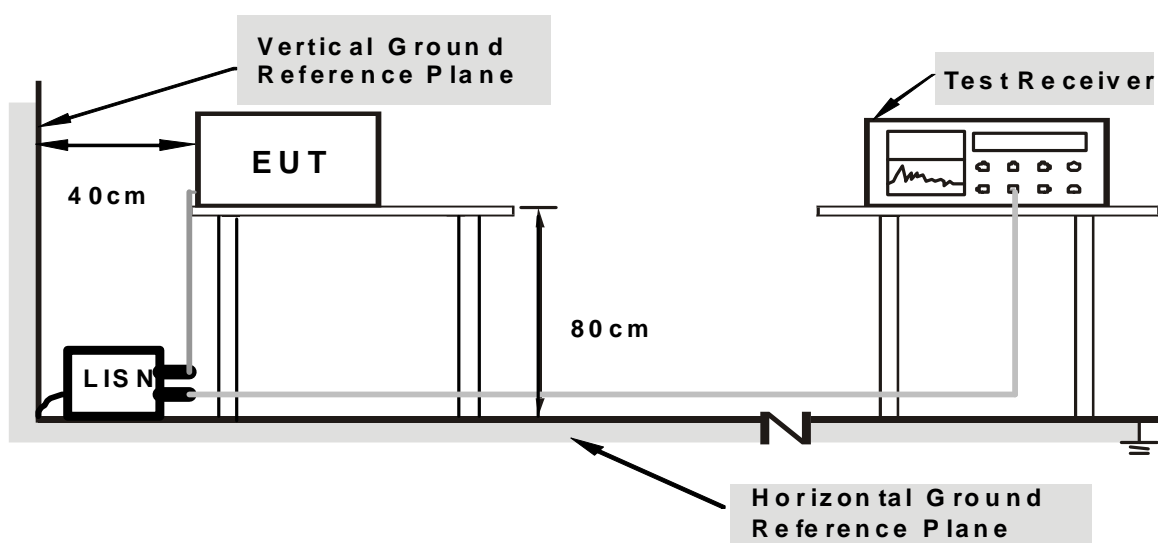

**Note: Support units were connected to second LISN.**

For the actual test configuration, please refer to the related item – Photographs of the Test Configuration.

## 5.4 Test Results

<b>Frequency Range</b>	150kHz ~ 30MHz	<b>Detector Function &amp; Bandwidth</b>	Quasi-Peak (QP), 9kHz
<b>Input Power</b>	230Vac, 50Hz	<b>Environmental Conditions</b>	24°C, 76%RH
<b>Tested by</b>	Chiawei Lin		
<b>Test Mode</b>	Mode 1		

Phase Of Power : Line (L)						
No	Freq. [MHz]	Corr.	Reading Value	Emission Level	Limit	Margin
		Factor	[dB (uV)]	[dB (uV)]	[dB (uV)]	(dB)
		(dB)	Q.P.	Q.P.	Q.P.	Q.P.
1	0.17734	9.70	43.89	53.59	99.00	-45.41
2	0.25538	9.70	40.80	50.50	99.00	-48.50
3	0.50538	9.70	28.20	37.90	93.00	-55.10
4	0.75028	9.72	23.44	33.16	93.00	-59.84
5	9.37500	9.91	24.69	34.60	93.00	-58.40
6	23.33594	9.96	18.84	28.80	93.00	-64.20

### REMARKS:

1. The emission levels of other frequencies were very low against the limit.
2. Margin value = Emission Level – Limit value
3. Correction Factor = Insertion loss + Cable loss
4. Emission Level = Correction Factor + Reading Value

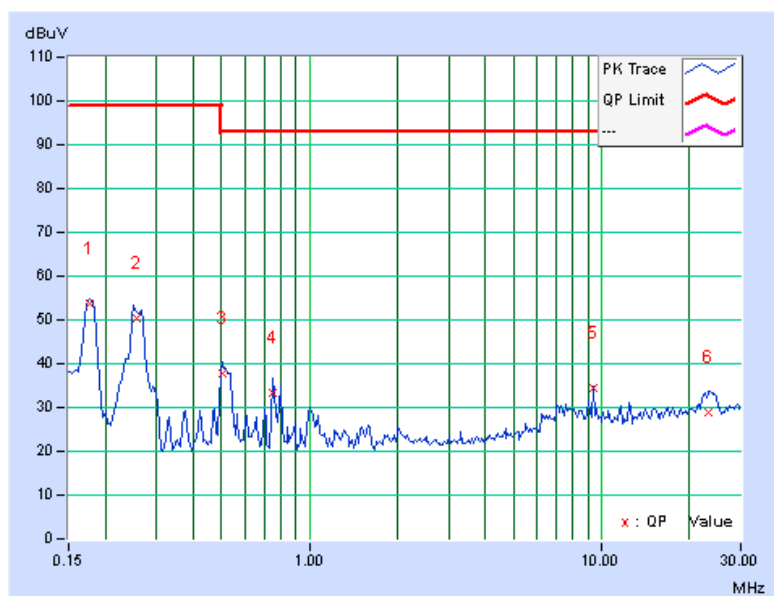

<b>Frequency Range</b>	150kHz ~ 30MHz	<b>Detector Function &amp; Bandwidth</b>	Quasi-Peak (QP), 9kHz
<b>Input Power</b>	230Vac, 50Hz	<b>Environmental Conditions</b>	24°C, 76%RH
<b>Tested by</b>	Chiawei Lin		
<b>Test Mode</b>	Mode 1		

Phase Of Power : Neutral (N)						
No	Freq. [MHz]	Corr.	Reading Value	Emission Level	Limit	Margin
		Factor	[dB (uV)]	[dB (uV)]	[dB (uV)]	(dB)
		(dB)	Q.P.	Q.P.	Q.P.	Q.P.
1	0.17472	9.70	42.90	52.60	99.00	-46.40
2	0.25538	9.69	41.15	50.84	99.00	-48.16
3	0.50537	9.70	28.38	38.08	93.00	-54.92
4	0.75156	9.71	22.49	32.20	93.00	-60.80
5	9.37500	9.90	25.14	35.04	93.00	-57.96
6	22.57031	9.95	24.12	34.07	93.00	-58.93

**REMARKS:**

1. The emission levels of other frequencies were very low against the limit.
2. Margin value = Emission Level – Limit value
3. Correction Factor = Insertion loss + Cable loss
4. Emission Level = Correction Factor + Reading Value

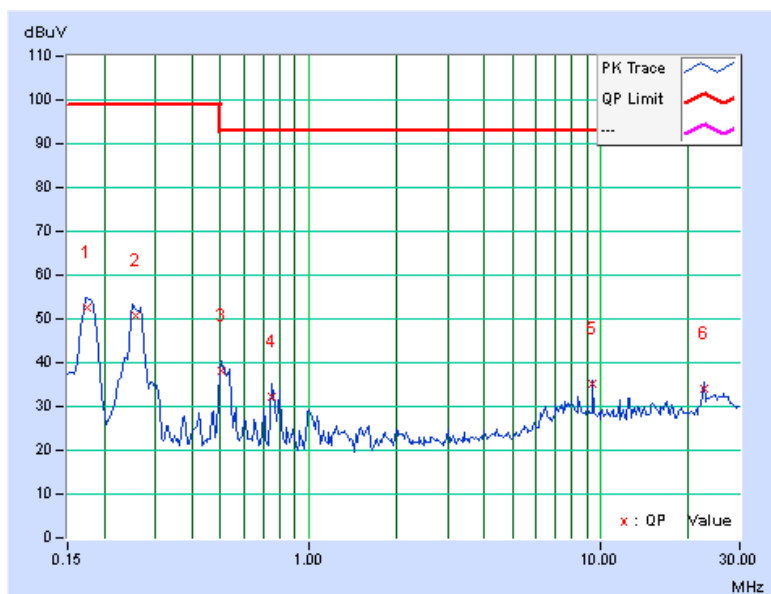

## 6 Radiated Disturbance up to 1 GHz

### 6.1 Limits

Frequency (MHz)	dBuV/m (at 10m) / quasi-peak
30 - 230	40
230 - 1000	47

- Notes:
1. The lower limit shall apply at the transition frequencies.
  2. Emission level (dBuV/m) = 20 log Emission level (uV/m).
  3. All emanations from a class A/B digital device or system, including any network of conductors and apparatus connected thereto, shall not exceed the level of field strengths specified above.

### 6.2 Test Instruments

Description & Manufacturer	Model No.	Serial No.	Cal. Date	Cal. Due
ROHDE & SCHWARZ TEST RECEIVER	ESCI	100744	Apr. 28, 2016	Apr. 27, 2017
Schaffner BILOG Antenna	CBL6111D	22270	Jan. 05, 2016	Jan. 04, 2017
CT Turn Table	TT100	CT-080	NA	NA
CT Tower	AT100	CT-080	NA	NA
Software	Radiated_V7.6.15.9.4	NA	NA	NA
ANRITSU RF Switches	MP59B	N/A	Mar. 11, 2016	Mar. 10, 2017
WOKEN RF cable With 5dB PAD	8D	CABLE-ST3-01	Mar. 11, 2016	Mar. 10, 2017

- Notes:
1. The calibration interval of the above test instruments is 12 months and the calibrations are traceable to NML/ROC and NIST/USA.
  2. The test was performed in Open Site No. 3.
  3. The VCCI Site Registration No. is R-269.
  4. The FCC Site Registration No. 90424.
  5. Tested Date: Jul. 11, 2016.

### 6.3 Test Arrangement

- The EUT was placed on the top of a rotating table 0.8 meters above the ground at an accredited test facility. The table was rotated 360 degrees to determine the position of the highest radiation.
- The EUT was set 10 meters away from the interference-receiving antenna, which was mounted on the top of a variable-height antenna tower.
- The antenna is a broadband antenna, and its height is varied from one meter to four meters above the ground to determine the maximum value of the field strength. Both horizontal and vertical polarizations of the antenna are set to make the measurement.
- For each suspected emission, the EUT was arranged to its worst case and then the antenna was tuned to heights from 1 meter to 4 meters and the rotatable table was turned from 0 degrees to 360 degrees to find the maximum reading.
- The test-receiver system was set to quasi-peak detect function and specified bandwidth with maximum hold mode when the test frequency is up to 1 GHz.

Note: The resolution bandwidth and video bandwidth of test receiver/spectrum analyzer is 120kHz for quasi-peak detection (QP) at frequency up to 1GHz.

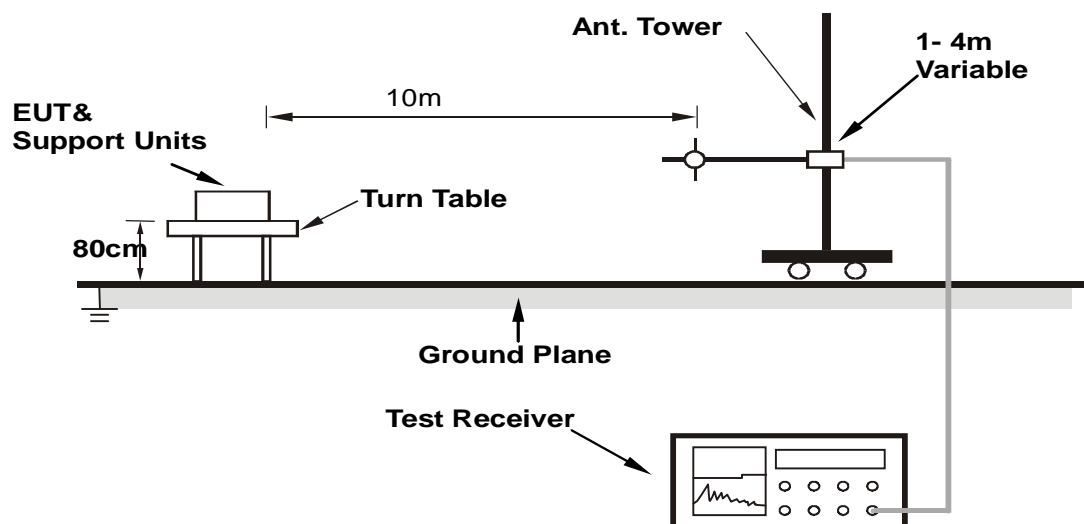

For the actual test configuration, please refer to the related item – Photographs of the Test Configuration.

## 6.4 Test Results

<b>Frequency Range</b>	30MHz ~ 1GHz	<b>Detector Function &amp; Bandwidth</b>	Quasi-Peak (QP), 120kHz
<b>Tested by</b>	Hermes Lin	<b>Environmental Conditions</b>	31°C, 75%RH
<b>Test Mode</b>	Mode 1		

### Antenna Polarity & Test Distance : Horizontal at 10 m

No	Frequency (MHz)	Emission Level (dBuV/m)	Limit (dBuV/m)	Margin (dB)	Antenna Height (m)	Table Angle (Degree)	Raw Value (dBuV)	Correction Factor (dB/m)
1	64.22	28.36 QP	40.00	-11.64	4.00 H	62	16.51	11.85
2	74.37	27.74 QP	40.00	-12.26	4.00 H	149	14.88	12.86
3	108.77	25.74 QP	40.00	-14.26	4.00 H	191	8.67	17.07
4	125.00	34.36 QP	40.00	-5.64	4.00 H	0	16.40	17.96
5	148.56	27.58 QP	40.00	-12.42	4.00 H	195	10.12	17.46
6	184.32	24.56 QP	40.00	-15.44	4.00 H	122	9.27	15.29
7	222.80	31.51 QP	40.00	-8.49	4.00 H	217	15.28	16.23
8	296.94	30.95 QP	47.00	-16.05	4.00 H	132	10.62	20.33
9	397.06	43.95 QP	47.00	-3.05	4.00 H	341	20.68	23.27
10	445.51	34.83 QP	47.00	-12.17	1.99 H	203	10.18	24.65
<b>11</b>	<b>742.50</b>	<b>44.99 QP</b>	<b>47.00</b>	<b>-2.01</b>	<b>1.38 H</b>	<b>297</b>	<b>41.71</b>	<b>3.28</b>
12	891.00	44.62 QP	47.00	-2.38	1.00 H	14	39.86	4.76

#### Remarks:

1. Emission Level(dBuV/m) = Raw Value(dBuV) + Correction Factor(dB/m)
2. Correction Factor(dB/m) = Antenna Factor (dB/m) + Cable Factor (dB)  
– Pre-Amplifier Factor (dB)
3. The other emission levels were very low against the limit.
4. Margin value = Emission level – Limit value

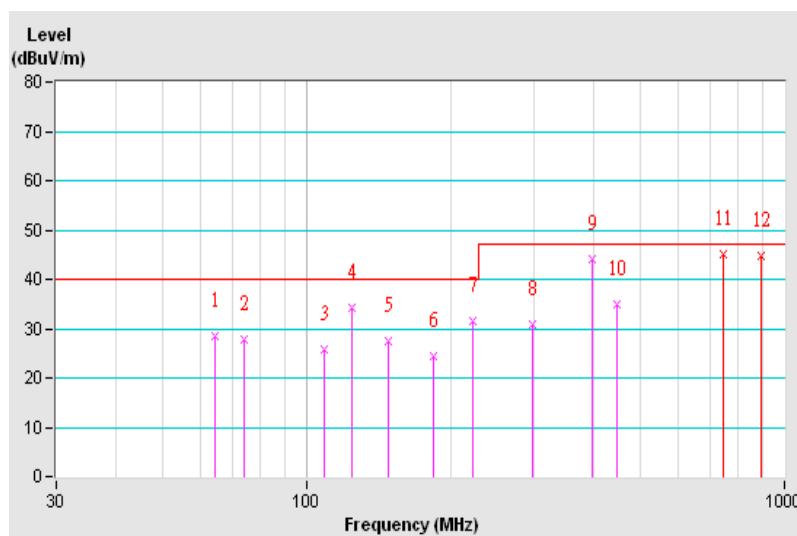

<b>Frequency Range</b>	30MHz ~ 1GHz	<b>Detector Function &amp; Bandwidth</b>	Quasi-Peak (QP), 120kHz
<b>Tested by</b>	Hermes Lin	<b>Environmental Conditions</b>	31°C, 75%RH
<b>Test Mode</b>	Mode 1		

**Antenna Polarity & Test Distance : Vertical at 10 m**

No	Frequency (MHz)	Emission Level (dBuV/m)	Limit (dBuV/m)	Margin (dB)	Antenna Height (m)	Table Angle (Degree)	Raw Value (dBuV)	Correction Factor (dB/m)
1	30.87	35.53 QP	40.00	-4.47	1.00 V	166	38.69	-3.16
2	66.11	33.73 QP	40.00	-6.27	1.00 V	276	21.78	11.95
3	74.22	36.00 QP	40.00	-4.00	1.00 V	244	23.15	12.85
4	111.39	36.94 QP	40.00	-3.06	1.00 V	235	19.71	17.23
5	125.00	32.07 QP	40.00	-7.93	1.00 V	284	14.11	17.96
6	148.48	31.17 QP	40.00	-8.83	1.00 V	245	13.70	17.47
7	184.32	25.92 QP	40.00	-14.08	1.00 V	193	10.63	15.29
8	222.80	28.83 QP	40.00	-11.17	1.00 V	118	12.60	16.23
9	296.94	34.07 QP	47.00	-12.93	1.00 V	205	13.74	20.33
10	408.20	36.26 QP	47.00	-10.74	1.00 V	108	12.43	23.83
11	445.61	29.76 QP	47.00	-17.24	1.25 V	357	5.11	24.65
12	499.99	39.95 QP	47.00	-7.05	1.57 V	240	14.23	25.72
13	742.50	43.90 QP	47.00	-3.10	2.67 V	318	40.62	3.28
14	891.00	43.86 QP	47.00	-3.14	1.62 V	171	39.10	4.76
15	928.50	40.30 QP	47.00	-6.70	1.48 V	209	7.48	32.82

Remarks:

1. Emission Level(dBuV/m) = Raw Value(dBuV) + Correction Factor(dB/m)
2. Correction Factor(dB/m) = Antenna Factor (dB/m) + Cable Factor (dB)  
– Pre-Amplifier Factor (dB)
3. The other emission levels were very low against the limit.
4. Margin value = Emission level – Limit value

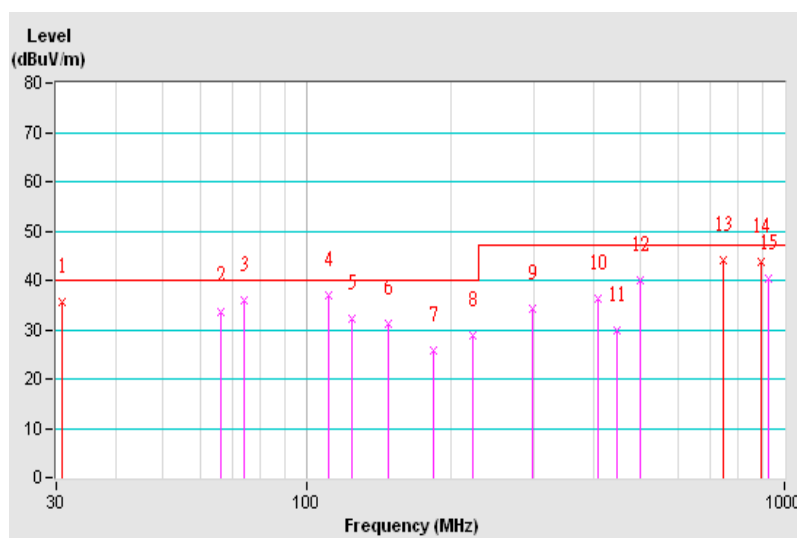

## 7 Electrostatic Discharge Immunity Test (ESD)

### 7.1 Test Specification

<b>Basic Standard:</b>	EN 61000-4-2
<b>Discharge Impedance:</b>	330 ohm / 150 pF
<b>Discharge Voltage:</b>	Air Discharge: $\pm 2\text{kV}$ , $\pm 4\text{kV}$ , $\pm 8\text{kV}$ (Direct) Contact Discharge: $\pm 2\text{kV}$ , $\pm 4\text{kV}$ , $\pm 6\text{kV}$ (Direct/Indirect)
<b>Number of Discharge:</b>	Minimum 20 times at each test point
<b>Discharge Mode:</b>	Single Discharge
<b>Discharge Period:</b>	1-second minimum

### 7.2 Test Instruments

Description & Manufacturer	Model No.	Serial No.	Cal. Date	Cal. Due
KeyTek, ESD Simulator	MZ-15/EC	0504259	Oct. 26, 2015	Oct. 25, 2016

- Notes:
1. The calibration interval of the above test instruments is 12 months and the calibrations are traceable to NML/ROC and NIST/USA.
  2. The test was performed in ESD Room No. 1.
  3. Tested Date: Jul. 14, 2016.



### 7.3 Test Arrangement

- a. Electrostatic discharges were applied only to those points and surfaces of the EUT that are accessible to users during normal operation.
- b. The test was performed with at least ten single discharges on the pre-selected points in the most sensitive polarity.
- c. The time interval between two successive single discharges was at least 1 second.
- d. The ESD generator was held perpendicularly to the surface to which the discharge was applied and the return cable was at least 0.2 meters from the EUT.
- e. Contact discharges were applied to the non-insulating coating, with the pointed tip of the generator penetrating the coating and contacting the conducting substrate.
- f. Air discharges were applied with the round discharge tip of the discharge electrode approaching the EUT as fast as possible (without causing mechanical damage) to touch the EUT. After each discharge, the ESD generator was removed from the EUT and re-triggered for a new single discharge. The test was repeated until all discharges were complete.
- g. At least ten single discharges (in the most sensitive polarity) were applied to the **Horizontal Coupling Plane** at points on each side of the EUT. The ESD generator was positioned at a distance of 0.1 meters from the EUT with the discharge electrode touching the **HCP**.
- h. At least ten single discharges (in the most sensitive polarity) were applied to the center of one vertical edge of the **Vertical Coupling Plane** in sufficiently different positions that the four faces of the EUT were completely illuminated. The **VCP** (dimensions 0.5m x 0.5m) was placed vertically to and 0.1 meters from the EUT.

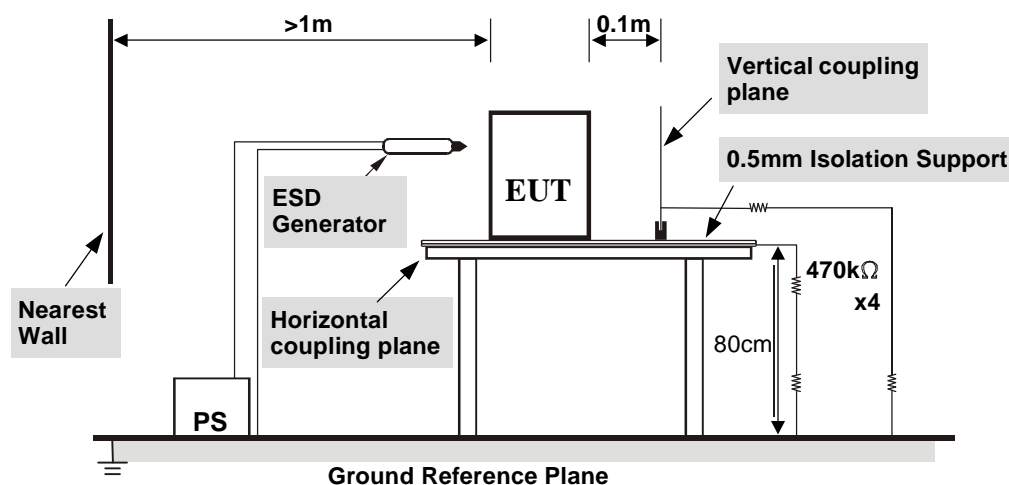

#### TABLE-TOP EQUIPMENT

The configuration consisted of a wooden table 0.8 meters high standing on the **Ground Reference Plane**. The **GRP** consisted of a sheet of aluminum at least 0.25mm thick, and 2.5 meters square connected to the protective grounding system. A **Horizontal Coupling Plane** (1.6m x 0.8m) was placed on the table and attached to the **GRP** by means of a cable with 940kΩ total impedance. The equipment under test, was installed in a representative system as described in section 7 of EN 61000-4-2, and its cables were placed on the **HCP** and isolated by an insulating support of 0.5mm thickness. A distance of 1-meter minimum was provided between the EUT and the walls of the laboratory and any other metallic structure.

For the actual test configuration, please refer to the related item – Photographs of the Test Configuration.

## 7.4 Test Results

Input Power	230 Vac, 50 Hz	Tested by	Joey Liu
Environmental Conditions	24 °C, 46% RH 1002 mbar	Test mode	Mode 1

### Test Results of Direct Application

Discharge Level (kV)	Polarity (+/-)	Test Point	Contact Discharge	Air Discharge	Performance Criterion
2	+/-	1-3	Note 1	NA	A
4, 6	+/-	1-3	Note 1	NA	A
2	+/-	4-11	NA	Note 1	A
4, 8	+/-	4, 6-11	NA	Note 2	B
2, 4, 8	+/-	12	NA	Note 1	A
4, 8	+/-	5	NA	Note 3	B

Description of test points of direct application: Please refer to following page for representative mark only.

### Test Results of Indirect Application

Discharge Level (kV)	Polarity (+/-)	Test Point	Horizontal Coupling Plane	Vertical Coupling Plane	Performance Criterion
2, 4, 6	+/-	Four Sides	Note 1	Note 1	A

Description of test points of indirect application:

1. Front side                      2. Rear side                      3. Right side                      4. Left side

- Note: 1. The EUT function was correct during the test.  
 2. The HDD Read & Write function of EUT was delayed 1-2 seconds during the test, but self-recoverable after the test.  
 3. The LAN transmission of EUT was timeout 1-2 seconds during the test, but self-recoverable after the test.

### Description of Test Points

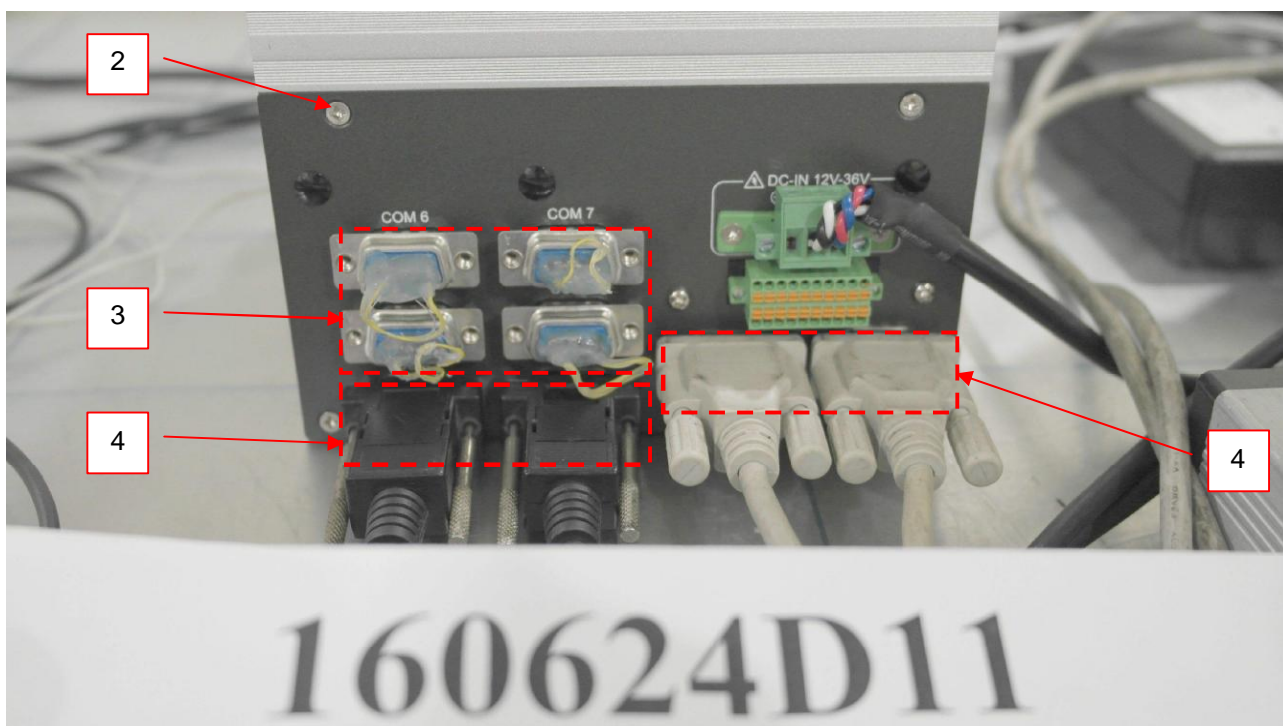
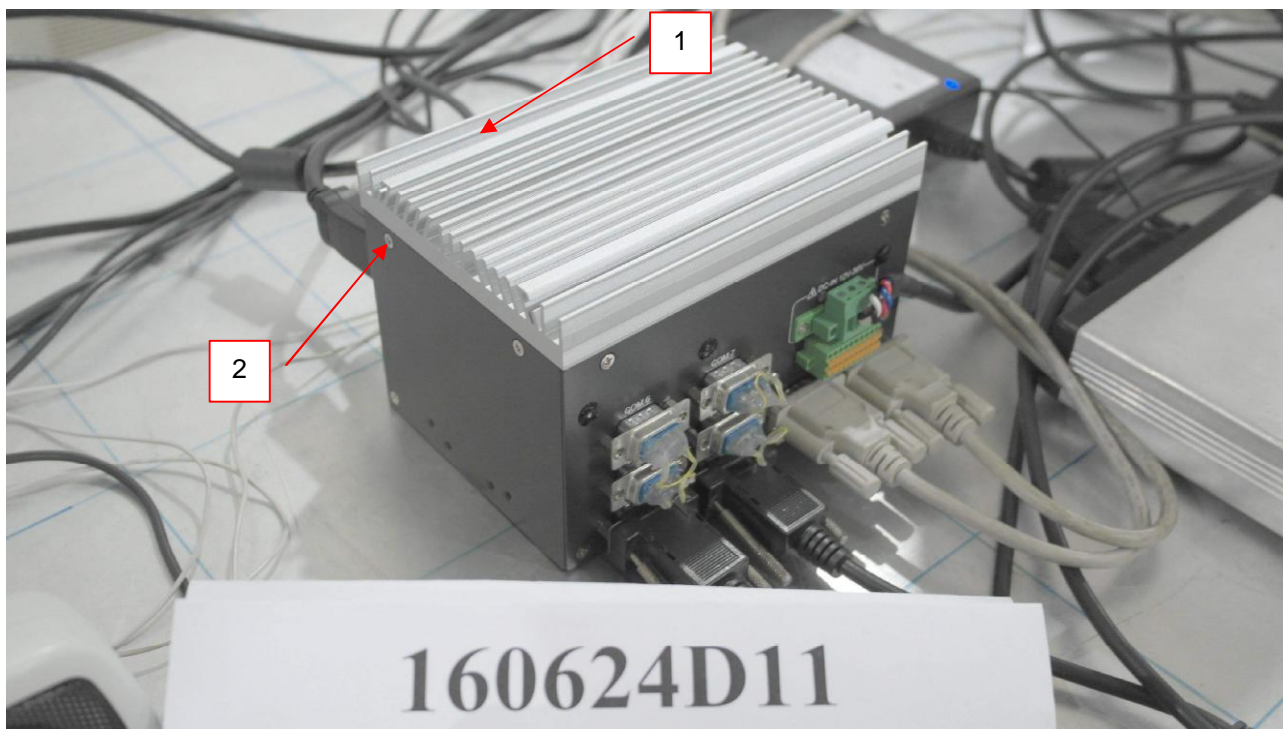

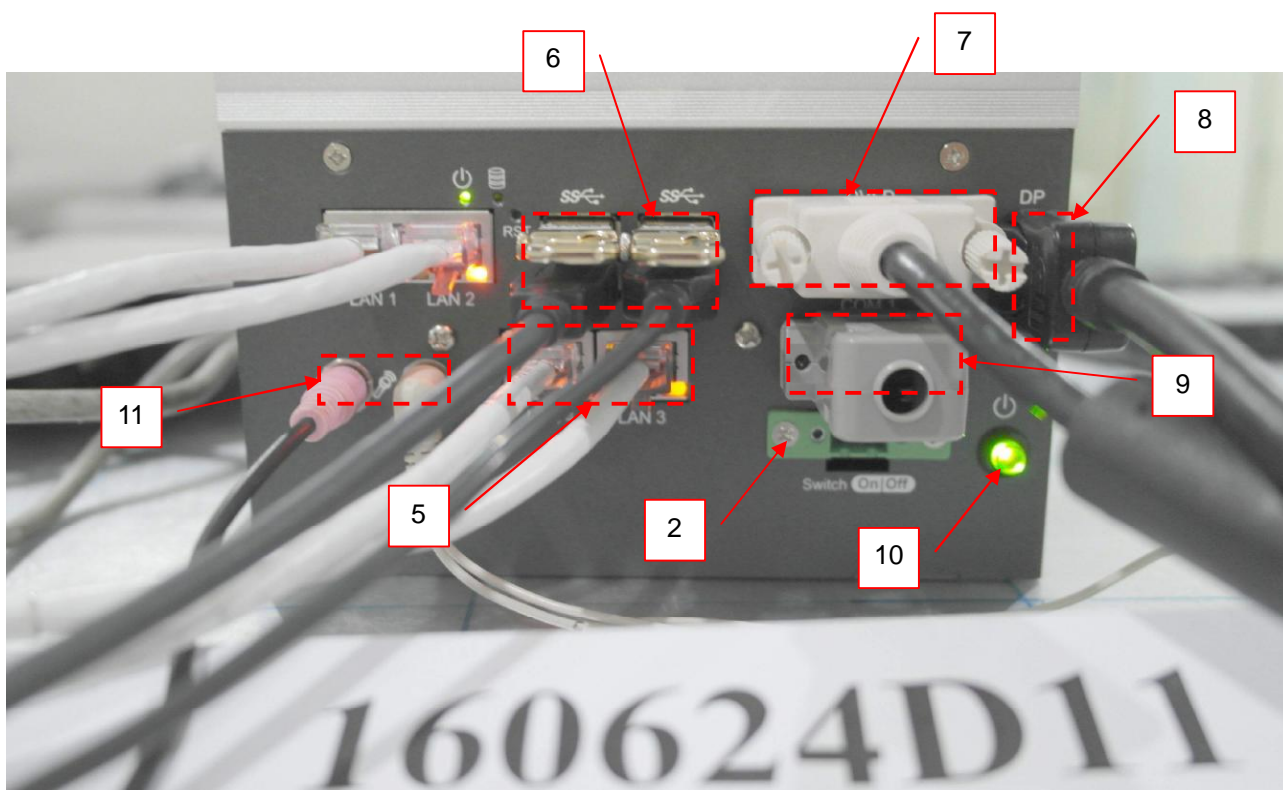
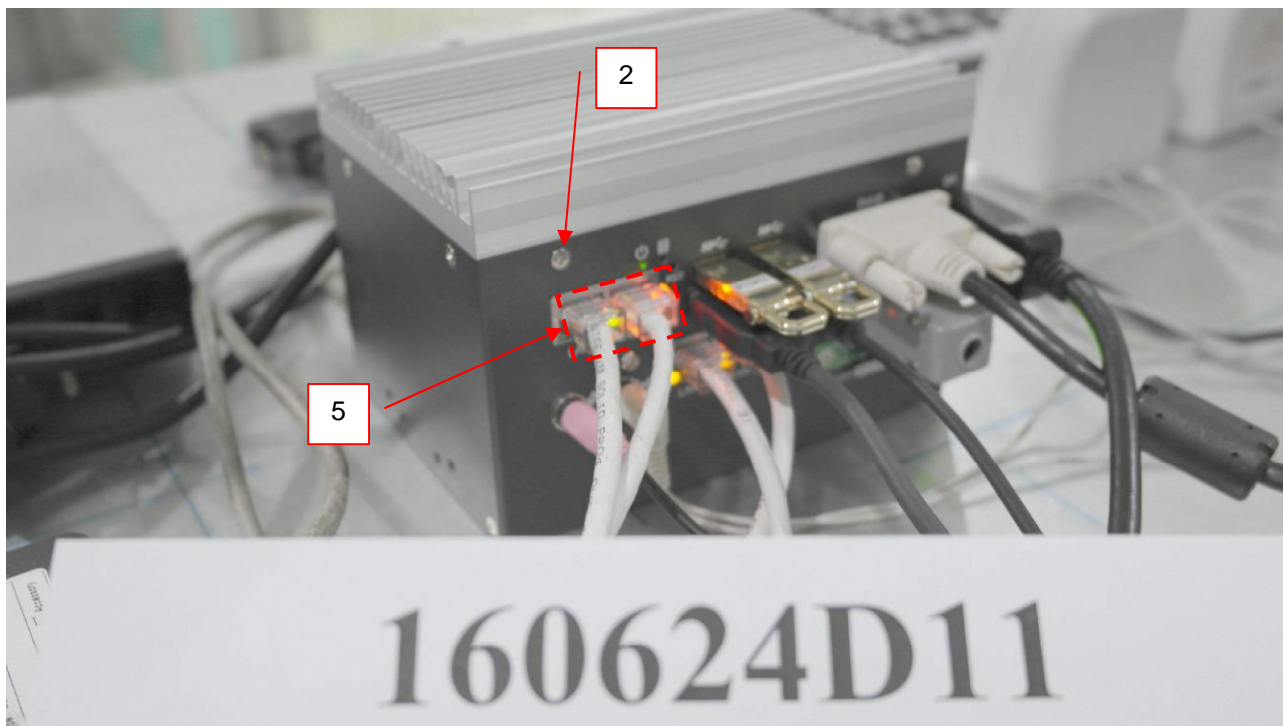

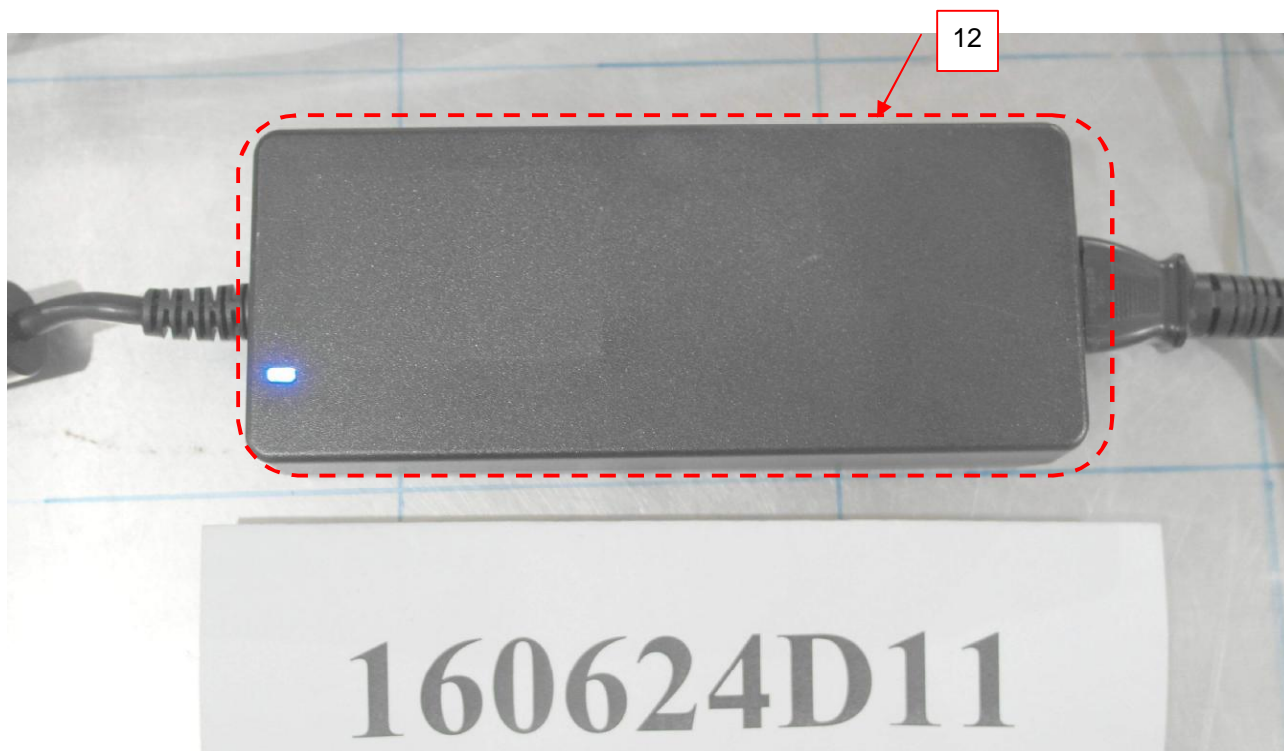



## 8 Radio-frequency Electromagnetic Field Immunity Test (RS)

### 8.1 Test Specification

Basic Standard:	EN 61000-4-3
	80-1000 MHz, 20V/m <sup>(1)</sup>
Frequency Range, Field Strength:	800-1000 MHz, 20V/m
	1400-2100 MHz, 10V/m
	2100-2500 MHz, 5V/m
Modulation:	1kHz Sine Wave, 80%, AM Modulation
Frequency Step:	1 % of preceding frequency value
Polarity of Antenna:	Horizontal and Vertical
Antenna Height:	1.5m
Dwell Time:	3 seconds

Note (1: This limit applies to equipment mounted in the passenger compartments, drivers cab or external to the rolling stock (roof, underframe). For equipment mounted in all other areas a severity level of 10 V/m may be used.

### 8.2 Test Instruments

Description & Manufacturer	Model No.	Serial No.	Cal. Date	Cal. Due
Agilent Signal Generator	E8257D	MY48050465	Jul. 21, 2015	Jul. 20, 2016
PRANA RF Amplifier	AP32DP280	0811-894	NA	NA
TESEQ RF Amplifier	CBA1G-150	T44220	NA	NA
AR RF Amplifier	35S4G8AM4	0326094	NA	NA
AR RF Amplifier	100S1G4M3	0329249	NA	NA
AR Controller	SC1000M3	305910	NA	NA
Narda Broadband Field Meter	NBM-550	B-0872	Feb. 09, 2016	Feb. 08, 2018
BOONTON RF Voltage Meter	4232A	10180	Jun. 01, 2016	May 31, 2017
BOONTON Power Sensor	51013-4E	34870	Jun. 01, 2016	May 31, 2017
BOONTON Power Sensor	51013-4E	34873	Jun. 01, 2016	May 31, 2017
AR Log-Periodic Antenna	AT6080	0329465	NA	NA
EMCO BiconiLog Antenna	3141	1001	NA	NA
AR High Gain Antenna	AT4002A	306533	NA	NA
AR High Gain Horn Antenna	AT4010	0329800	NA	NA
CHANCE MOST Full Anechoic Chamber (9x5x3m)	Chance Most	RS-002	Feb. 05, 2016	Feb. 04, 2017
Software	RS_V7.6	NA	NA	NA

- Notes:
1. The calibration interval of the above test instruments is 12 months and the calibrations are traceable to NML/ROC and NIST/USA.
  2. The test was performed in RS Room No.2.
  3. Tested Date: Jul. 15, 2016.

### 8.3 Test Arrangement

The test procedure was in accordance with EN 61000-4-3.

- a. The testing was performed in a modified semi-anechoic chamber.
- b. The frequency ranges and field strength levels are 80-1000 MHz, 20V/m, 800-1000 MHz, 20V/m, 1400-2100 MHz, 10V/m and 2100-2500 MHz, 5V/m with the signal 80% amplitude modulated with a 1kHz sine wave.
- c. The test was performed with the EUT exposed to both vertically and horizontally polarized fields on each of the four sides.

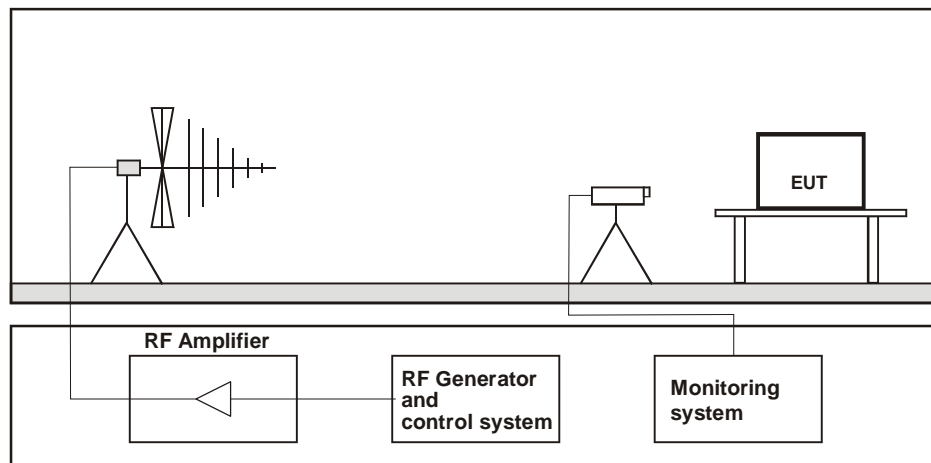

#### Table-top Equipment

The EUT installed in a representative system as described in section 7 of EN 61000-4-3 was placed on a non-conductive table 0.8 meters in height. The system under test was connected to the power and signal wire according to relevant installation instructions.

For the actual test configuration, please refer to the related item – Photographs of the Test Configuration.

#### 8.4 Test Results

Input Power	230 Vac, 50 Hz	Tested by	Ken Chen
Environmental Conditions	25°C, 65% RH	Test mode	Mode 1

Frequency (MHz)	Polarity	Azimuth(°)	Applied Field Strength		Observation	Test Distance (m)	Performance Criterion
			(V/m)	Modulation			
80 - 1000	V&H	0, 90, 180, 270	20	80% AM (1kHz)	Note	1.5	A
800 - 1000	V&H	0, 90, 180, 270	20	80% AM (1kHz)	Note	1.5	A
1400 - 2100	V&H	0, 90, 180, 270	10	80% AM (1kHz)	Note	3	A
2100 - 2500	V&H	0, 90, 180, 270	5	80% AM (1kHz)	Note	3	A

Note: The EUT function was correct during the test.



## 9 Electrical Fast Transient/Burst Immunity Test (EFT)

### 9.1 Test Specification

Basic Standard:	EN 61000-4-4
Test Voltage:	Signal & communication, process measurement & control ports: $\pm 2\text{kV}$ , Capacitive clamp Auxiliary a.c. power input ports (rated voltage $\leq 400\text{ Vrms}$ ): $\pm 2\text{kV}$
Impulse Repetition Frequency:	5kHz
Impulse Wave Shape:	5/50 ( $T_r/T_h$ ) ns
Burst Duration:	15 ms
Burst Period:	300 ms
Test Duration:	1 min.

### 9.2 Test Instruments

Description & Manufacturer	Model No.	Serial No.	Cal. Date	Cal. Due
Haefely, EFT Generator	PEFT 4010	154954	Apr. 20, 2016	Apr. 19, 2017
Haefely, Capacitive Clamp	IP4A	155173	Apr. 20, 2016	Apr. 19, 2017

- Notes:
1. The calibration interval of the above test instruments is 12 months and the calibrations are traceable to NML/ROC and NIST/USA.
  2. The test was performed in EFT Room.
  3. Tested Date: Jul. 14, 2016.

### 9.3 Test Arrangement

- Both positive and negative polarity discharges were applied.
- The distance between any coupling devices and the EUT should be 0.5 m for table-top equipment testing, and 1.0 m for floor standing equipment.
- The duration time of each test sequential was 1 minute.
- The transient/burst waveform was in accordance with EN 61000-4-4, 5/50 ns.

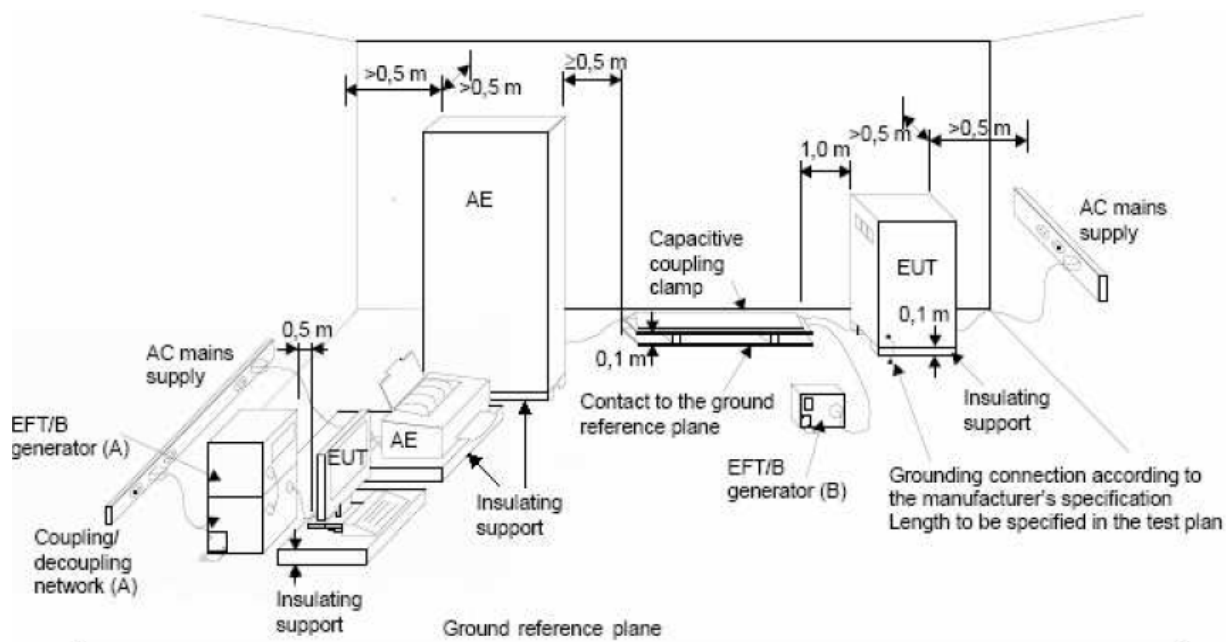

**NOTE:**

- (A) location for supply line coupling
- (B) location for signal lines coupling

For the actual test configuration, please refer to the related item – Photographs of the Test Configuration.

#### 9.4 Test Results

Input Power	230 Vac, 50 Hz	Tested by	Joey Liu
Environmental Conditions	24°C, 55% RH	Test mode	Mode 1

Auxiliary a.c. power input ports (rated voltage  $\leq$  400 Vrms)

Voltage (kV)	Test Point	Polarity (+/-)	Observation	Performance Criterion
2	L1	+/-	Note	B
2	L2	+/-	Note	B
2	PE	+/-	Note	B
2	L1-L2-PE	+/-	Note	B

Signal & communication, process measurement & control ports

Voltage (kV)	Test Point	Polarity (+/-)	Observation	Performance Criterion
2	LAN*2	+/-	Note	B

Note: The LAN transmission of EUT was timeout 3-10 seconds during the test, but self-recoverable after the test.

## 10 Surge Immunity Test

### 10.1 Test Specification

Basic Standard:	EN 61000-4-5
Wave-Shape:	Auxiliary a.c. power input ports (rated voltage $\leq 400$ Vrms): 1.2/50 $\mu$ s Open Circuit Voltage 8/20 $\mu$ s Short Circuit Current
Test Voltage:	Line to line: $\pm 0.5$ kV, $\pm 1$ kV, Line to ground: $\pm 0.5$ kV, $\pm 1$ kV, $\pm 2$ kV output impedance of 42 $\Omega$ (40 $\Omega$ and 2 $\Omega$ generator) and a coupling capacitance of 0,5 $\mu$ F
AC Phase Angle (degree):	0°, 90°, 180°, 270°
Pulse Repetition Rate:	1 time / 20 sec.
Number of Tests:	5 positive and 5 negative at selected points

### 10.2 Test Instruments

Description & Manufacturer	Model No.	Serial No.	Cal. Date	Cal. Due
TESEQ, Surge Simulator	NSG 3060	1572	May 19, 2016	May 18, 2017
TESEQ, CDN	CDN 3083-100	1215	May 19, 2016	May 18, 2017
Coupling Decoupling Network	CDN-UTP8	028	Aug. 20, 2015	Aug. 19, 2016
TESEQ Coupling Decoupling Network	CDN HSS-2	41009	May 21, 2016	May 20, 2017
TESEQ Coupling Decoupling Networ	CDN 118-T8	40386	Aug. 31, 2015	Aug. 30, 2016

- Notes:
1. The calibration interval of the above test instruments is 12 months and the calibrations are traceable to NML/ROC and NIST/USA.
  2. The test was performed in EMS Room No. 2.
  3. Tested Date: Jul. 20, 2016.

### 10.3 Test Arrangement

The surge is to be applied to the EUT power supply terminals via the capacitive coupling network. Decoupling networks are required in order to avoid possible adverse effects on equipment not under test that may be powered by the same lines, and to provide sufficient decoupling impedance to the surge wave. The power cord between the EUT and the coupling/decoupling networks shall be 2 meters in length (or shorter).

For double-insulated products without PE or external earth connections, the test shall be done in a similar way as for grounded products but without adding any additional external grounded connections. If there are no other possible connections to earth, line-to-ground tests may be omitted.

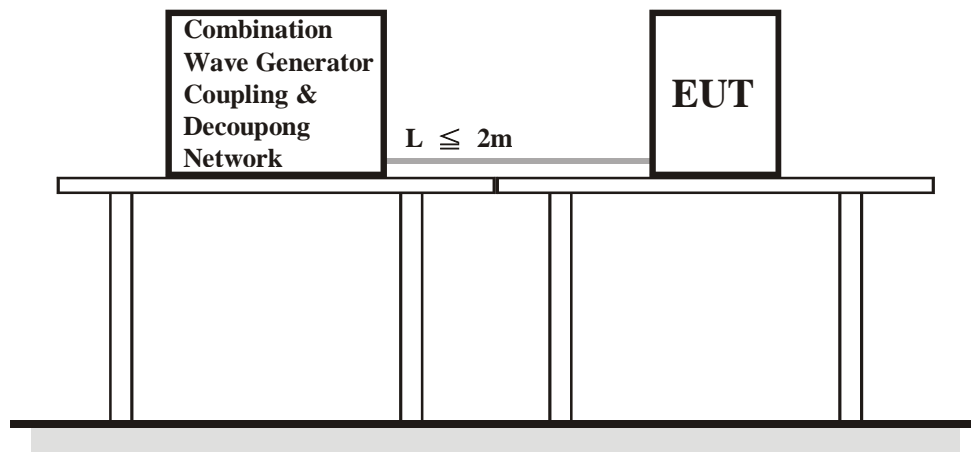

For the actual test configuration, please refer to the related item – Photographs of the Test Configuration.

#### 10.4 Test Results

Input Power	230 Vac, 50 Hz	Tested by	Aga Lin
Environmental Conditions	26 °C, 66% RH	Test mode	Mode 1

Auxiliary a.c. power input ports (rated voltage  $\leq$  400 Vrms)

Voltage (kV)	Test Point	Polarity (+/-)	Observation	Performance Criterion
0.5, 1	L1-L2	+/-	Note	A
0.5, 1, 2	L1-PE	+/-	Note	A
0.5, 1, 2	L2-PE	+/-	Note	A

Note: The EUT function was correct during the test.

## 11 Immunity to Conducted Disturbances Induced by RF Fields (CS)

### 11.1 Test Specification

Basic Standard:	EN 61000-4-6
Frequency Range:	0.15 MHz - 80 MHz
Voltage Level:	Auxiliary a.c. power input ports (rated voltage $\leq 400$ Vrms), Signal & communication, process measurement & control ports: 10 V
Modulation:	1kHz Sine Wave, 80%, AM Modulation
Frequency Step:	1 % of preceding frequency value
Dwell Time	3 seconds

## 11.2 Test Instruments

Description & Manufacturer	Model No.	Serial No.	Cal. Date	Cal. Due
ROHDE & SCHWARZ Signal Generator	SML03	101801	Jan. 07, 2016	Jan. 06, 2017
Digital Sweep Function Generator	8120	984801	NA	NA
AR Power Amplifier	75A250AM1	306331	NA	NA
FCC Coupling Decoupling Network	FCC-801-M3-25A	48	Jun. 23, 2016	Jun. 22, 2017
FCC Coupling Decoupling Network	FCC-801-M2-16A	01047	Jun. 23, 2016	Jun. 22, 2017
FISCHER CUSTOM COMMUNICATIONS EM Injection Clamp	F-203I-23mm	455	NA	NA
FISCHER CUSTOM COMMUNICATIONS Current Injection Clamp	F-120-9A	361	NA	NA
B&K Ear Simulator	4185	2553594	NA	NA
EM TEST Coupling Decoupling Network	CDN M1/32A	306508	Jun. 23, 2016	Jun. 22, 2017
TESEQ Coupling Decoupling Network	CDN T800	34428	Jun. 23, 2016	Jun. 22, 2017
FCC Coupling Decoupling Network	FCC-801-T4	02031	Jun. 23, 2016	Jun. 22, 2017
EM TEST Coupling Decoupling Network	CDN T2	306509	Jun. 23, 2016	Jun. 22, 2017
R&S Power Sensor	NRV-Z5	837878/039	Oct. 26, 2015	Oct. 25, 2016
R&S Power Meter	NRVD	837794/040	Oct. 27, 2015	Oct. 26, 2016
TESEQ Coupling Decoupling Network	CDN M232	37702	Aug. 18, 2015	Aug. 17, 2016
TESEQ Coupling Decoupling Network	CDN M332	41258	Sep. 22, 2015	Sep. 21, 2016
TESEQ Coupling Decoupling Network	CDN M332	41256	Aug. 20, 2015	Aug. 19, 2016
TESEQ Coupling Decoupling Network	CDN T400A	28569	Aug. 17, 2015	Aug. 16, 2016
TESEQ Coupling Decoupling Network	CDN T8-10	40376	Aug. 17, 2015	Aug. 16, 2016
Software	CS_V7.4.2	NA	NA	NA

- Notes:
1. The calibration interval of the above test instruments is 12 months and the calibrations are traceable to NML/ROC and NIST/USA.
  2. The test was performed in CS Room No. 1.
  3. Tested Date: Jul. 14, 2016.



### 11.3 Test Arrangement

- The EUT shall be tested within its intended operating and climatic conditions.
- An artificial hand was placed on the hand-held accessory and connected to the ground reference plane.
- One of the CDNs not used for injection was terminated with 50 ohm, providing only one return path. All other CDNs were coupled as decoupling networks.
- The frequency range is swept from 150 kHz to 80 MHz, using the signal level established during the setting process and with a disturbance signal of 80 % amplitude. The signal is modulated with a 1 kHz sine wave, pausing to adjust the RF signal level or the switch coupling devices as necessary. Where the frequency is swept incrementally, the step size shall not exceed 1 % of the preceding frequency value.
- Attempts should be made to fully exercise the EUT during testing, and to fully interrogate all exercise modes selected for susceptibility.

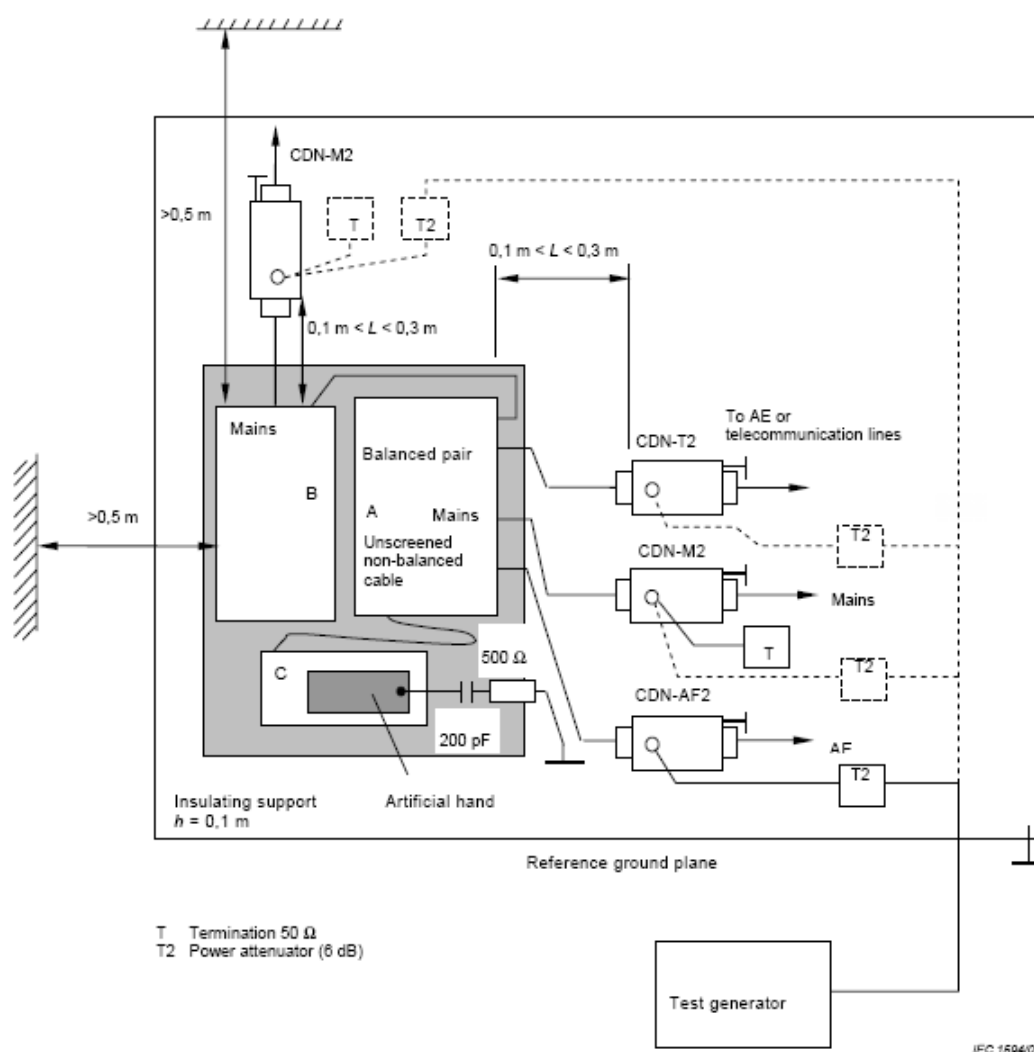

- Note:**
- The EUT clearance from any metallic obstacles shall be at least 0,5 m.
  - Interconnecting cables ( $\leq 1$  m) belonging to the EUT shall remain on the insulating support.
  - The equipment to be tested is placed on an insulating support of 0.1 meters height above a ground reference plane. All relevant cables shall be provided with the appropriate coupling and decoupling devices at a distance between 0.1 meters and 0.3 meters from the projected geometry of the EUT on the ground reference plane.

For the actual test configuration, please refer to the related item – Photographs of the Test Configuration.

#### 11.4 Test Results

Input Power	230 Vac, 50 Hz	Tested by	Joey Liu
Environmental Conditions	25°C, 55% RH	Test mode	Mode 1

Frequency (MHz)	Level (V rms)	Tested Line	Injection Method	Return Path	Observation	Remark	Performance Criterion
0.15 – 80	10	AC Power	CDN-M3	EM-Clamp	Note	-	A
0.15 – 80	10	STP LAN*2	EM-Clamp	CDN-M3	Note	-	A

Note: The EUT function was correct during the test.

## 12 Pictures of Test Arrangements

### 12.1 Conducted Disturbance at Auxiliary a.c. or d.c. power ports

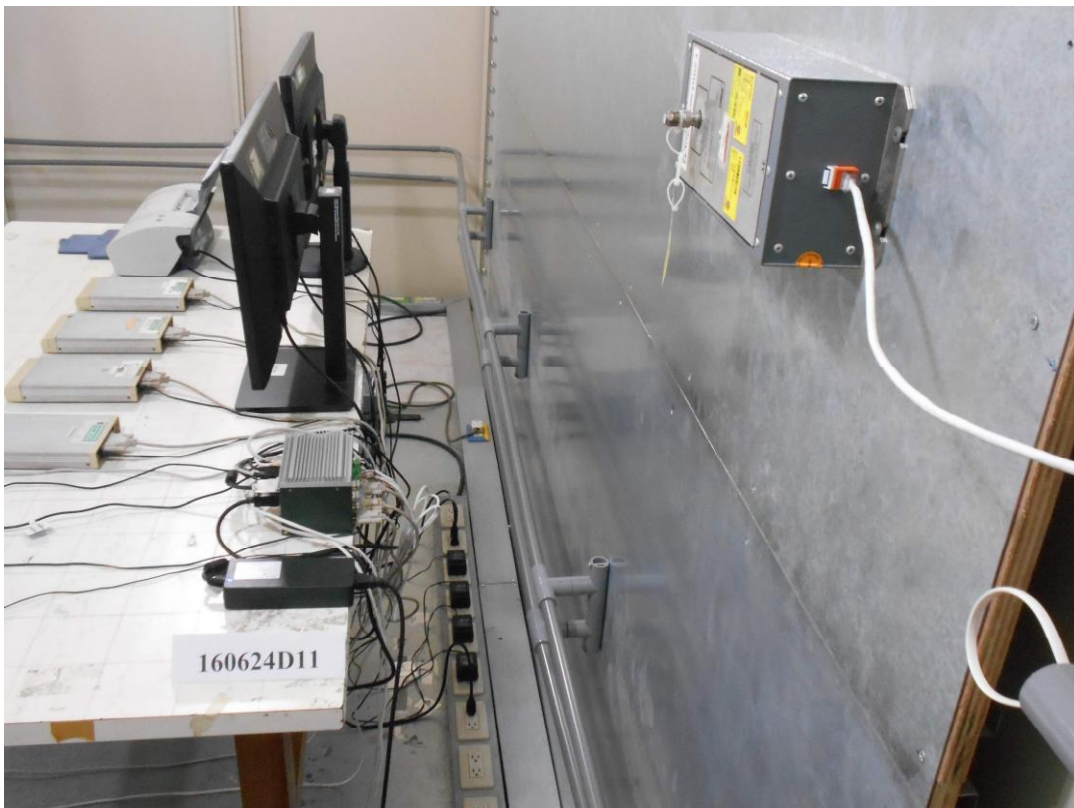

## 12.2 Radiated Disturbance up to 1 GHz

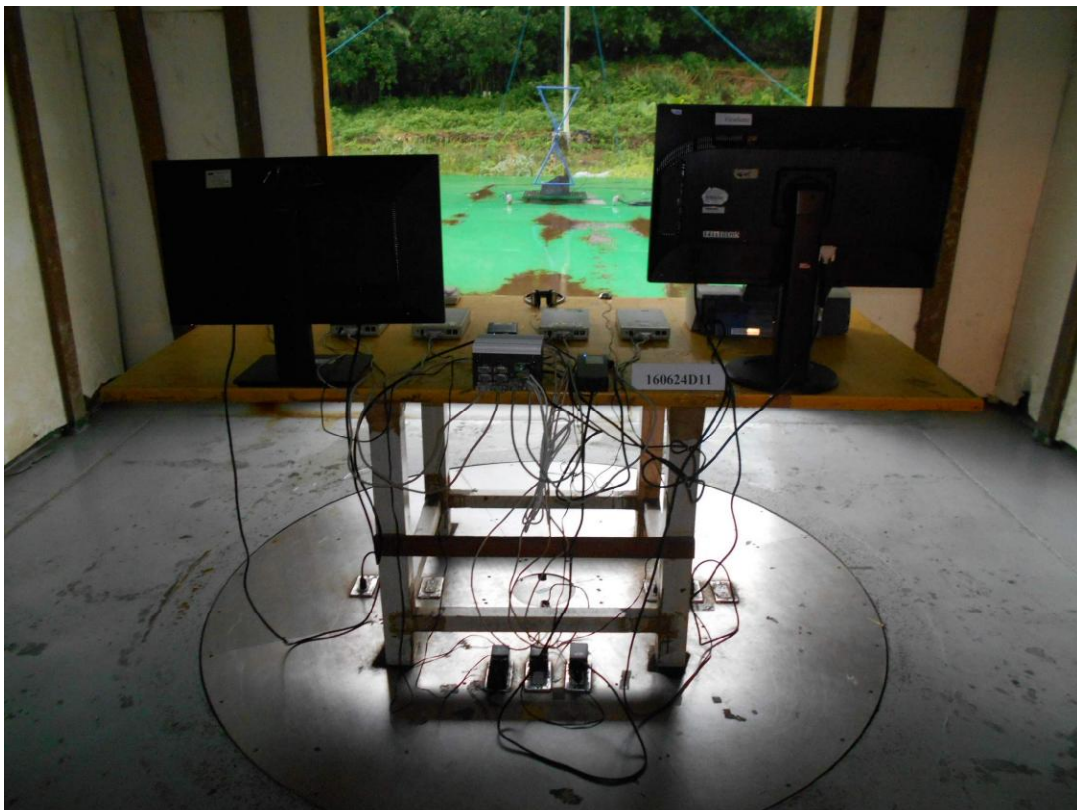



### 12.3 Electrostatic Discharge Immunity Test (ESD)



## 12.4 Radio-frequency Electromagnetic Field Immunity Test (RS)

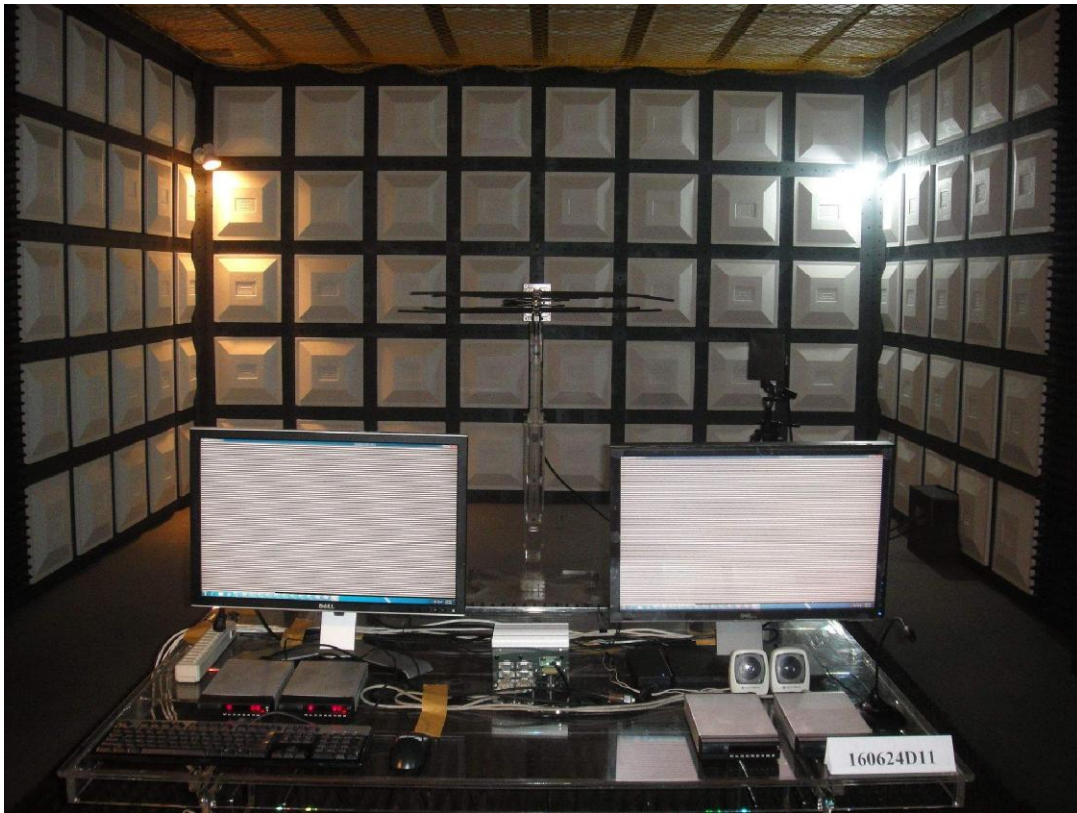

## 12.5 Fast Transients (EFT)

Mains ports

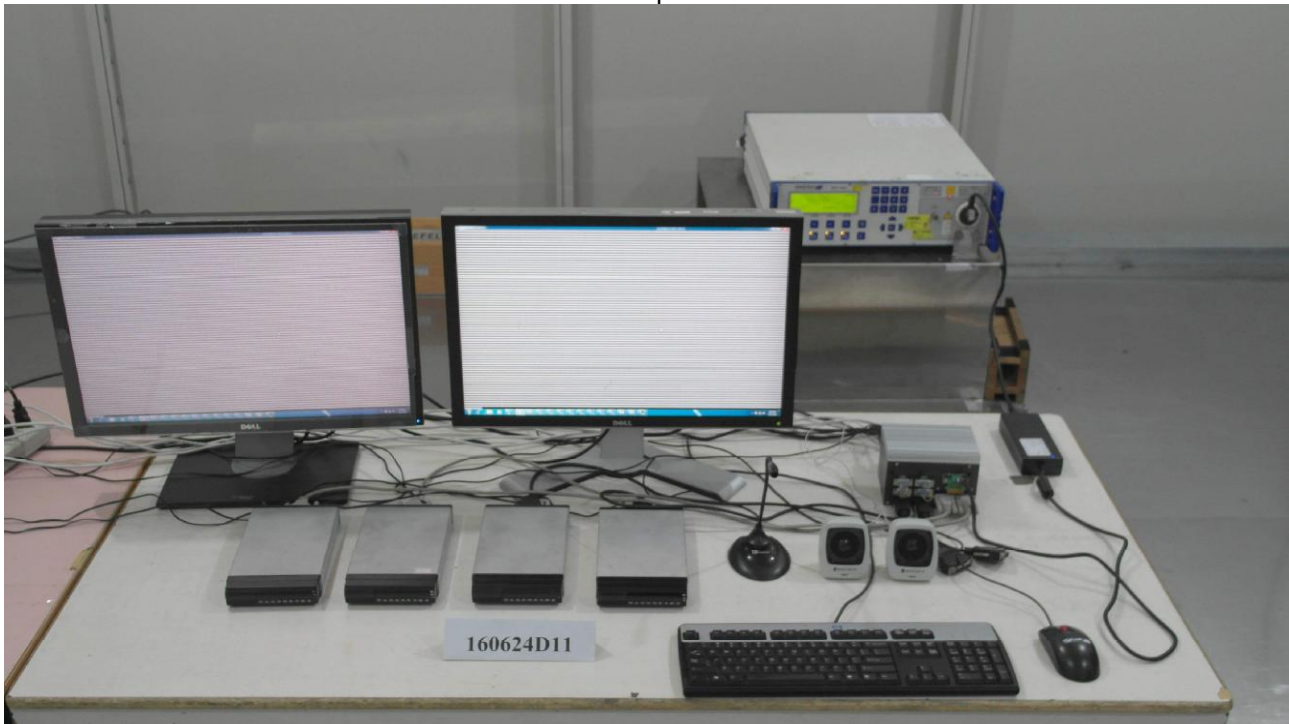

LAN

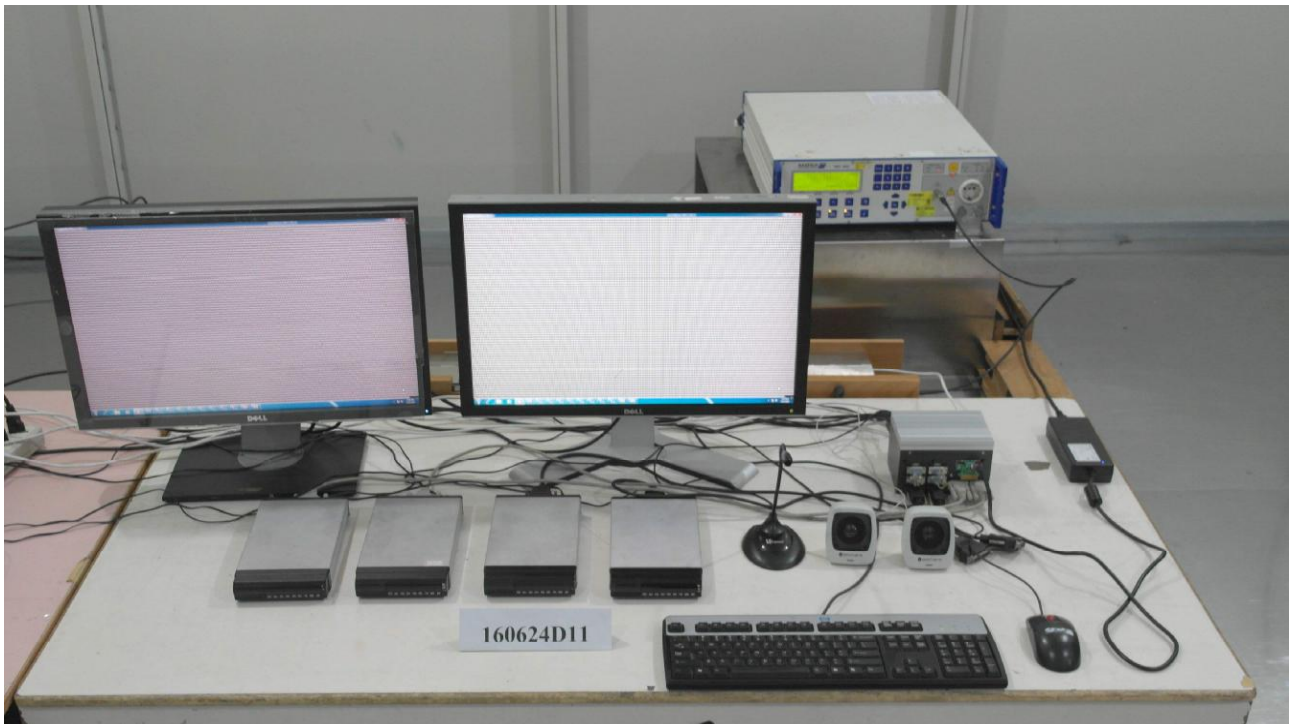



## 12.6 Surge

### Mains ports





## 12.7 Radio-frequency common mode (CS)

Mains ports

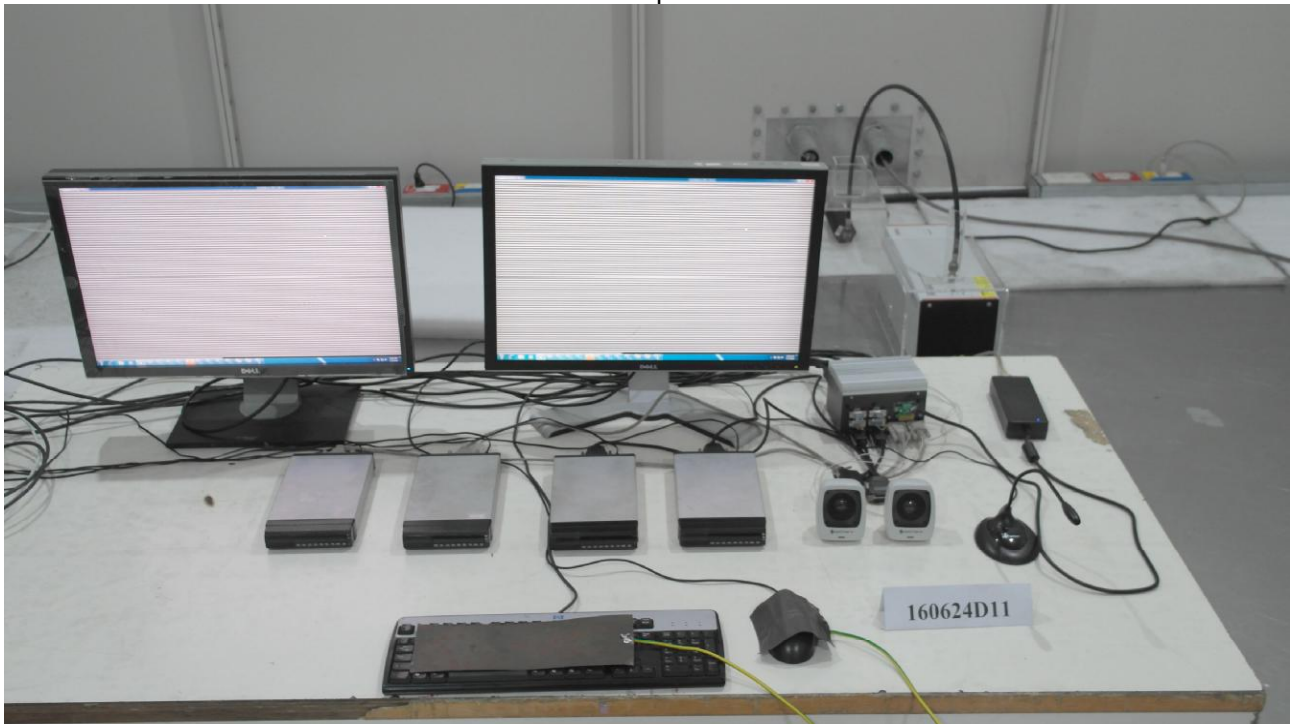

STP LAN

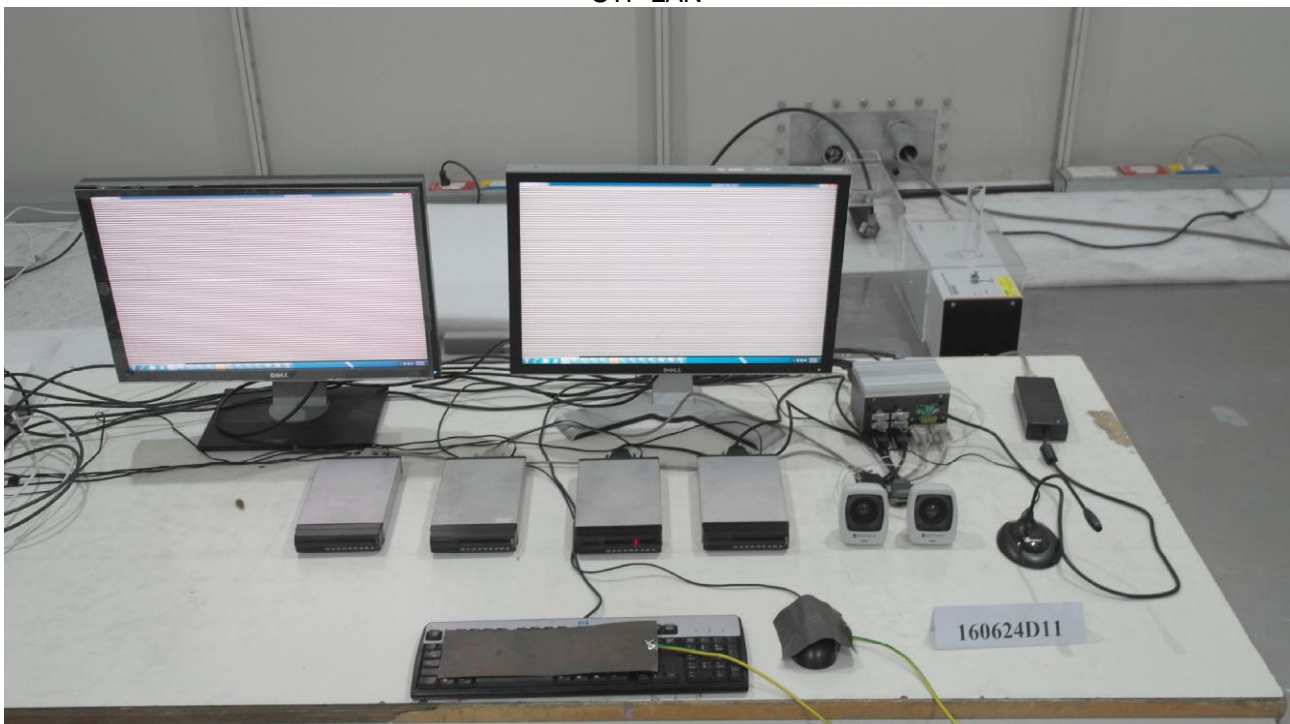

## Appendix – Information on the Testing Laboratories

We, Bureau Veritas Consumer Products Services (H.K.) Ltd., Taoyuan Branch, were founded in 1988 to provide our best service in EMC, Radio, Telecom and Safety consultation. Our laboratories are accredited and approved according to ISO/IEC 17025.

If you have any comments, please feel free to contact us at the following:

**Linko EMC/RF Lab**

Tel: 886-2-26052180

Fax: 886-2-26051924

**Hsin Chu EMC/RF/Telecom Lab**

Tel: 886-3-6668565

Fax: 886-3-6668323

**Hwa Ya EMC/RF/Safety Lab**

Tel: 886-3-3183232

Fax: 886-3-3270892

**Email:** [service.adt@tw.bureauveritas.com](mailto:service.adt@tw.bureauveritas.com)

**Web Site:** [www.bureauveritas-adt.com](http://www.bureauveritas-adt.com)

The address and road map of all our labs can be found in our web site also.

--- END ---